

STATE OF NORTH CAROLINA
DEPARTMENT OF TRANSPORTATION

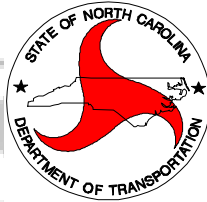

DIVISION 6 - DISTRICT 2

CONTRACT PROPOSAL

**GRADE, DRAIN, BASE, PAVE AND
REPLACE PERMITTED PIPES**

WBS NUMBER: 6C.043122
ROUTE: SR 2309 (LEANNA LANE)
COUNTIES: HARNETT
DESCRIPTION: GRADE, DRAIN, BASE, PAVE & REPLACE PERMITTED PIPES

BID OPENING: JULY 22, 2015 - 10:00AM

NOTICE:

ALL BIDDERS SHALL COMPLY WITH ALL APPLICABLE LAWS REGULATING THE PRACTICE OF GENERAL CONTRACTING AS CONTAINED IN CHAPTER 87 OF THE GENERAL STATUTES OF NORTH CAROLINA WHICH REQUIRES THE BIDDER TO BE LICENSED BY THE N.C. LICENSING BOARD FOR CONTRACTORS WHEN BIDDING ON ANY NON-FEDERAL AID PROJECT WHERE THE BID IS \$50,000 OR MORE, EXCEPT FOR CERTAIN SPECIALTY WORK AS DETERMINED BY THE LICENSING BOARD OR SBE PROJECT. BIDDERS SHALL ALSO COMPLY WITH ALL OTHER APPLICABLE LAWS REGULATING THE PRACTICES OF ELECTRICAL, PLUMBING, HEATING AND AIR CONDITIONING AND REFRIGERATION CONTRACTING AS CONTAINED IN CHAPTER 87 OF THE GENERAL STATUTES OF NORTH CAROLINA.

NAME OF BIDDER

N.C. CONTRACTOR'S LICENSE NUMBER

ADDRESS OF BIDDER

RETURN BIDS TO:

R. ALLEN WADDELL, PE, DIVISION PROPOSALS ENGINEER
NORTH CAROLINA DEPARTMENT OF TRANSPORTATION
558 GILLESPIE STREET
FAYETTEVILLE, NC 28301

TABLE OF CONTENTS

General Provisions

Instruction to Bidders	5
General	6
Division Let Contract Prequalification	6
Authority of the Engineer	7
District Contacts.....	7
Bids.....	7
Prosecution and Progress	7
Contract Time and Liquidated Damages	8
Temporary Suspension of Work	8
Intermediate Contract Time Number One (1) and Liquidated Damages.....	9
Intermediate Contract Time Number Two (2) and Liquidated Damages.....	9
Safety and Accident Protection.....	10
Posted Weight Limits	10
Subletting of Contract	10
Coordination with Others	10
Safety Vests	10
Conformity with the Contract	10
Utility Conflicts	11
Subsurface Information.....	11
Notification of Operations	11
Material and Equipment Storage and Parking	11
Responsibility for Damage Claims	11
Vendor Numbers.....	12
Bankruptcy.....	12
Traffic Control and Work Zone Safety.....	12
Flaggers.....	13
Supervision by Contractor	13
Liability Insurance.....	13
Contract Payment and Performance Bond	14
Retainage and Prompt Payment.....	14
Partial Payment	15
Claims for Additional Compensation or Extension of Time	15
Invoices for Payment	15
Outsourcing Outside the USA.....	15
Maintenance of Project.....	16
Twelve Month Guarantee	16
Materials and Testing	17
Inspection	17
Engineering Control	17
Debarment Statement.....	17
Gifts from Vendors and Contractors	17
Indemnification.....	18
Contractor Claim Submittal Form.....	18
Availability of Funds-Termination of Contracts	19
Default of Contract.....	19
Employment.....	19

Project Special Provisions

Notification of Operations	20
Interpretation of Quantities in Proposal Form	20

TABLE OF CONTENTS (Continued)

Driveways and Private Property.....	20
Traffic Signs & Mailboxes	20
Equipment	20
Mobilization.....	20
Waste and Borrow Sources	21
Undercut Excavation.....	21
Borrow Material.....	22
Shoulder and Slope Borrow.....	22
Select Material	23
Foundation Conditioning Material	24
Pipe Culverts	24-25
Pipe Removal	25
Comprehensive Grading	26
Aggregate Base Course	27
Incidental Stone Base.....	27
Asphalt Binder	28
Asphalt Binder Content of Asphalt Plant Mixes	28
Price Adjustment – Asphalt Binder for Plant Mix.....	28
Quality Management System for Asphalt Plant Mix Pavements	28
Paving.....	29
Pavement Quantities	29
Asphalt Pavements – Warm Mix Asphalt Superpave.....	30
Pavement Markings.....	30
Asphalt Pavements – Superpave.....	31
Utility Construction.....	32
General Utility Requirements.....	32-33
Water Line	34
Utility Controls (Hydrants/Valves/Meters)	35-36
Construction Box / Rain Gage	36
Stabilization Guidelines	36
Erosion, Siltation, and Pollution Control.....	37
Permanent Vegetation Establishment.....	38
Temporary Silt Fence	38
Temporary Mulching/Seed for Temp. Seeding/Fertilizer for Temp. Seeding ..	39
Safety Fence	40
Rolled Erosion Control Products (Excelsior Matting)	41
Wattle with Polyacrylamide (PAM).....	42-43
Seeding and Mulching (Permanent)	43-44
Temporary Rock Silt Check Type A with Excelsior Matting and PAM.....	45
Temporary Rock Silt Checks	46
Special Sediment Control Fence	47
Dewatering	47
Rip Rap.....	48
Permits	49
Erosion & Sediment Control/Stormwater Certification	50-53
Guidance on Complying with the Applicable Requirements of NCG01.....	54-55

Standard Special Provisions

Award of Contract.....	56
NCDOT General Seed Specification for Seed Quality	57-58
Errata.....	59-60
Plant and Pest Quarantines.....	60
Minimum Wages.....	61
Minority Business Enterprise and Women Business Enterprise	62-72

Details

Vicinity Map	73
Typical Section	74
2 Foot Widening.....	75
Fire Hydrant Relocation	76
Water Meter Relocation	77
Temporary Rock Silt Check, Type A, with Matting and PAM	78
Dewatering – Bypass Pumping.....	79
Permitted Pipe Replacement – Site #1 (Plan View).....	80
Permitted Pipe Replacement – Site #1 (Profile View).....	81
Permitted Pipe Replacement – Site #2 (Plan View).....	82
Permitted Pipe Replacement – Site #2 (Profile View).....	83
Wetland Delineation (Plan View)	84

Forms

Award Limits on Multiple Contracts.....	85
Non Collusion Affidavit (Debarment Certification).....	86-93
Substitute Form W-9.....	94
Listing of MB & WB Subcontractors.....	95-96
Form DBE-IS (Subcontractor Payment Information).....	97
Division Contract Bid Form	98-101

INSTRUCTIONS TO BIDDERS

**PLEASE READ ALL INSTRUCTIONS CAREFULLY
BEFORE PREPARING AND SUBMITTING YOUR BID.**

All bids shall be prepared and submitted in accordance with the following requirements. Failure to comply with any requirement shall cause the bid to be considered irregular and shall be grounds for rejection of the bid.

1. The bid sheet furnished by NC DOT with the proposal shall be used and shall not be altered in any manner. **DO NOT SEPARATE THE BID SHEET FROM THE PROPOSAL!**
2. All entries on the bid sheet, including signatures, shall be written in ink.
3. The Bidder shall submit a unit price for every item on the bid form. The unit prices for the various contract items shall be written in figures.
4. An amount bid shall be entered on the bid sheet for every item. The amount bid for each item shall be determined by multiplying each unit bid by the quantity for that item, and shall be written in figures in the "Amount Bid" column of the sheet.
5. The total amount bid shall be written in figures in the proper place on the bid sheet. The total amount shall be determined by adding the amounts bid for each item.
6. Changes in any entry shall be made by marking through the entry in ink and making the correct entry adjacent thereto in ink. A representative of the Bidder shall initial the change in ink.
7. The bid shall be properly executed. All bids shall show the following information:
 - a. Name of individual, firm, corporation, partnership, or joint venture submitting bid.
 - b. Name and signature of individual or representative submitting bid and position or title.
 - c. Name, signature, and position or title of witness.
 - d. Federal Identification Number (or Social Security Number of Individual)
 - e. Contractor's License Number (if Applicable)
8. Bids submitted by corporations shall bear the seal of the corporation on the W-9 and the Bid forms.
9. The bid shall not contain any unauthorized additions, deletions, or conditional bids.
10. The bidder shall not add any provision reserving the right to accept or reject an award, or to enter into a contract pursuant to an award.
11. The Form entitled "LISTING OF MBE & WBE SUBCONTRACTORS" must be filled out for Subcontractors submitting quotes for work on this contract. The Contractor shall then submit this form with the bid package.
12. **The Proposal with the bid sheet still attached** shall be placed in a sealed envelope and shall have been delivered to and received in the Division Proposals Engineer's Office at 558 Gillespie Street, Fayetteville, NC, 28301, by **10:00 am on Wednesday, July 22, 2015**. If bids are mailed or sent by special delivery, the Contractor shall be responsible for verifying that the bid has actually been received in the Division Proposals Engineer's Office prior to the bid deadline. NCDOT shall not be responsible for bid packages that do not arrive in our office on time. Bid packages arriving after the official deadline shall not be considered responsive, and shall be returned to the Contractor unopened.
13. **The sealed bid envelope must display the bidding Contractor's name and address on the front.**
14. The sealed bid envelope must display the following statement on the front of the sealed envelope:

**GRADE, DRAIN, BASE, PAVE & REPLACE PERMITTED PIPES – SR 2309
HARNETT COUNTY
JULY 22, 2015 - 10:00 AM**
15. If delivered by mail, the sealed envelope shall be placed in another sealed envelope and the outer envelope shall be addressed as follows:

**R. ALLEN WADDELL, P.E.
DIVISION PROPOSALS ENGINEER
NCDOT – DIVISION 6
P.O. BOX 1150
FAYETTEVILLE, NC 28302**

DIVISION CONTRACT

General Provisions

GENERAL

This contract is for grade, drain, base, pave and replace permitted pipes **SR 2309 (Leanna Lane)** in Harnett County.

All work and materials shall be in accordance with the provisions of the General Guidelines of this contract, the Project Special Provisions, the North Carolina Department of Transportation Standard Specifications for Roads and Structures 2012, the North Carolina Department of Transportation Roadway Standards Drawings, and the current edition of the Manual of Uniform Traffic Control Devices (MUTCD) or as directed by the Engineer.

The Contractor shall keep himself fully informed of all Federal, State and local laws, ordinances, and regulations, and shall comply with the provisions of Section 107 of the Standard Specifications.

The contractor shall coordinate all work with the Department. A pre-construction conference shall be held prior to beginning work.

DIVISION LET CONTRACT PREQUALIFICATION

(07-01-14)(6-1-15)

SPD 01-410

Any firm that wishes to bid as a prime contractor shall be prequalified as a Bidder or PO Prime Contractor prior to submitting a bid. Information regarding prequalification can be found at: <https://connect.ncdot.gov/business/Prequal/Pages/default.aspx>.

In addition, the prime contractor and/or subcontractor(s) shall be prequalified in the work code(s) for which they identify as work items in the prime contractor's construction progress schedule that they will complete themselves. Any contractor identified as working outside their expertise may be considered in default of contract.

AUTHORITY OF THE ENGINEER

(01-30-14)

105-1

SPD 01-460

The Engineer for this project shall be the Division Engineer, Division Six, Division of Highways, North Carolina Department of Transportation, acting directly or through his duly authorized representative.

The Engineer will decide all questions which may arise as to the quality and acceptability of work performed and as to the rate of progress of the work; all questions which may arise as to the interpretation of the contract; and all questions as to the acceptable fulfillment of the contract on the part of the Contractor. His decision shall be final and he shall have executive authority to enforce and make effective such decisions and orders as the Contractor fails to carry out promptly. The Engineer for this project is Mr. Randy K. Wise, PE.

DISTRICT CONTACTS

Upon award of the contract, the District contact will be Mr. Troy L. Baker (Assistant District Engineer)
▶ Telephone: (910) 486-1496 ▶ Email: tbaker@ncdot.gov

BIDS

In accordance with GS 136-28.1(b), if the total bid amount of the contract exceeds **\$2,500,000**, the bid will not be considered for award. In addition, a bid tabulation will not be posted or distributed until after the project has been awarded. Also, if the project is not awarded, a bid tabulation will not be posted or distributed.

PROSECUTION AND PROGRESS

The Contractor shall pursue the work diligently with workmen in sufficient numbers, abilities, and supervision, and with equipment, materials, and methods of construction as may be required to complete the work described in the contract by the completion date and in accordance with Section 108 of the Standard Specifications.

The Contractor's operations are restricted to daylight hours. **No work may be performed on Sundays and/or Legal State holidays.** Work shall only be performed when weather and visibility conditions allow safe operations.

The Contractor shall temporarily remove his equipment from the travel way for emergency vehicles and school buses as directed by the Engineer.

CONTRACT TIME AND LIQUIDATED DAMAGES

(7-1-95) (Rev. 12-18-07)

108

SP1 G10 A

THE DATE OF AVAILABILITY FOR THIS PROJECT IS THE DATE OF PURCHASE ORDER ISSUANCE.

THE INTERMEDIATE COMPLETION DATE FOR THIS PROJECT IS November 18, 2015.

INVOICES FOR ANY WORK PERFORMED PRIOR TO THE INTERMEDIATE COMPLETION DATE SHALL BE RECEIVED IN THE DISTRICT ENGINEER'S OFFICE ONE (1) WEEK PRIOR TO THE INTERMEDIATE COMPLETION DATE.

THE COMPLETION DATE FOR THIS PROJECT IS June 15, 2016. THE FINAL INVOICE SHALL BE RECEIVED IN THE DISTRICT ENGINEER'S OFFICE WITHIN ONE (1) WEEK OF THE COMPLETION DATE.

No extensions will be authorized except as authorized by Article 108-10 of the Standard Specifications.

Asphalt placement operations shall not be performed on this project before March 15, 2015 or between December 15, 2015 and March 16, 2016 unless authorized by the Engineer.

The Contractor may begin work prior to this date upon approval of the Engineer or his duly authorized representative. If such approval is given, and the Contractor begins work prior to the date of availability, the Department of Transportation will assume no responsibility for any delays caused prior to the date of availability by any reason whatsoever, and such delays, if any, will not constitute a valid reason for extending the completion date. No work will be permitted and no purchase order will be issued until all required bonds and pre-requisite conditions and certifications have been satisfied.

The Contractor shall request a pre-construction conference no later than 1 month after the date of availability. Contact Mr. Troy L. Baker (Assistant District Engineer) @ 910-486-1496.

Except where otherwise provided by the contract, observation periods required by the contract will not be a part of the work to be completed by the completion date and/or intermediate contract times stated in the contract. The acceptable completion of the observation periods that extend beyond the final completion date shall be a part of the work covered by the performance and payment bonds.

The liquidated damages for this contract are **Five Hundred Dollars (\$500.00)** per calendar day.

TEMPORARY SUSPENSION OF WORK

In accordance with Article 108-7 of the Standard Specifications, the Engineer will have the authority to suspend the work wholly or in part, any written order for such periods as he may deem necessary for any of the following reasons.

1. Conditions considered unfavorable for the suitable prosecution of the work, or
2. The Contractor's failure for correct conditions unsafe for workmen or the general public, or
3. The Contractor has not carried out orders given to him by the Engineer, or
4. The Contractor's failure to perform any provisions of the contract.

No extension of the completion date will be allowed for the above suspensions except as may be provided for in Article 108-10.

INTERMEDIATE CONTRACT TIME NUMBER ONE (1) AND LIQUIDATED DAMAGES

(6-18-13)

108

SP1 G14 L

The Contractor shall complete the work required of clearing and grubbing within the right of way in accordance with Section 200 of the Standard Specifications. These areas shall be permanent seeded within seven (7) days of completing the clearing and grubbing. All applicable erosion control devices shall be installed during this time.

The date of availability for this intermediate contract time is The Date of Purchase Order Issuance.

The completion date for this intermediate contract time is **November 18, 2015**.

The liquidated damages are **One Thousand Dollars (\$1,000.00)** per calendar day.

INTERMEDIATE CONTRACT TIME NUMBER TWO (2) AND LIQUIDATED DAMAGES

(2-20-07)

108

SP1 G14 B

The Contractor shall not narrow or close a lane of traffic on **SR 2309 (Leanna Lane)** detain and /or alter the traffic flow on or during holiday weekends, special events, or any other time when traffic is unusually heavy, including the following schedules:

HOLIDAY AND HOLIDAY WEEKEND LANE CLOSURE RESTRICTIONS

1. For **unexpected occurrence** that creates unusually high traffic volumes, as directed by the Engineer.
2. For **New Year's Day**, between the hours of **4:00 p.m.** December 31st and **8:30 a.m.** January 2nd. If New Year's Day is on a Friday, Saturday, Sunday or Monday, then until **8:30 a.m.** the following Tuesday.
3. For **Martin Luther King, Jr. Day**, between the hours of **4:00 p.m.** Friday and **8:30 a.m.** Tuesday.
4. For **Easter**, between the hours of **4:00 p.m.** Thursday and **8:30 a.m.** Monday.
5. For **Memorial Day**, between the hours of **4:00 p.m.** Friday and **8:30 a.m.** Tuesday.
6. For **Independence Day**, between the hours of **4:00 p.m.** the day before Independence Day and **8:30 a.m.** the day after Independence Day.
If **Independence Day** is on a Friday, Saturday, Sunday or Monday, then between the hours of **4:00 p.m.** the Thursday before Independence Day and **8:30 a.m.** the Tuesday after Independence Day.
7. For **Labor Day**, between the hours of **4:00 p.m.** Friday and **8:30 a.m.** Tuesday.
8. For **Veteran's Day**, between the hours of **4:00 p.m.** Friday and **8:30 a.m.** Tuesday.
9. For **Thanksgiving Day**, between the hours of **4:00 p.m.** Tuesday and **8:30 a.m.** Monday.
10. For **Christmas**, between the hours of **4:00 p.m.** the Friday before the week of Christmas Day and **8:30 a.m.** the following Tuesday after the week of Christmas Day.

Holidays and holiday weekends shall include New Year's, Martin Luther King Jr. Day, Easter, Memorial Day, Independence Day, Labor Day, Veteran's Day, Thanksgiving, and Christmas. The Contractor shall schedule his work so that lane closures are not required during these periods, unless otherwise directed by the Engineer.

The time of availability for this intermediate contract work shall be the time the Contractor begins to install all traffic control devices for lane closures according to the time restrictions listed herein.

The completion time for this intermediate contract work shall be the time the Contractor is required to complete the removal of all traffic control devices for lane closures according to the time restrictions stated herein and place traffic in an **existing traffic** pattern.

The liquidated damages for lane closures are **Five Hundred Dollars (\$ 500.00)** per hour.

SAFETY AND ACCIDENT PROTECTION

In accordance with Article 107-21 of the Standard Specifications, the Contractor shall comply with all applicable Federal, State, and local laws, ordinances, and regulations governing safety, health, and sanitation, and shall provide all safeguards, safety devices, and protective equipment, and shall take any other needed actions, on his own responsibility that are reasonably necessary to protect the life and health of employees on the job and the safety of the public, and to protect property in connection with the performance of the work covered by the contract.

POSTED WEIGHT LIMITS

The Contractor's attention is directed to the fact that many primary and secondary roads and bridges are posted with weight limits less than the legal limit. The Contractor will not be allowed to exceed the posted weight limits in transporting materials or equipment to the project. The Contractor should make a thorough examination of all maps and haul routes on this project.

SUBLETTING OF CONTRACT

(11-18-2014)

108-6

SP1 G186

Revise the *2012 Standard Specifications* as follows:

Page 1-66, Article 108-6 Subletting of Contract, line 37, add the following as the second sentence of the first paragraph:

All requests to sublet work shall be submitted within 30 days of the date of availability or prior to expiration of 20% of the contract time, whichever date is later, unless otherwise approved by the Engineer.

Page 1-67, Article 108-6 Subletting of Contract, line 7, add the following as the second sentence of the fourth paragraph:

Purchasing materials for subcontractors is not included in the percentage of work required to be performed by the Contractor. If the Contractor sublets items of work but elects to purchase material for the subcontractor, the value of the material purchased will be included in the total dollar amount considered to have been sublet.

COORDINATION WITH OTHERS

The Contractor shall coordinate with the school personnel for possible conflicts and/or delays with school activities if the project is located within five miles of the school. All work shall be scheduled to minimize interference with all school traffic.

SAFETY VESTS

All Contractors' personnel, all subcontractors and their personnel, and any material suppliers and their personnel shall wear a reflective vest or outer garment conforming to the requirements of MUTCD at all times while on the project.

CONFORMITY WITH THE CONTRACT

The presence of the engineer or an inspector at the work site shall in no way lessen the contractor's responsibility for conformity with the provisions of this contract. Should the engineer or inspector fail to point out work that does not conform with the plans and specifications, whether from lack of discovery or for any other reason, it shall in no way prevent later rejection or correction to the unsatisfactory work when discovered. The contractor shall have no claim for losses suffered due to any necessary removals or repairs resulting from unsatisfactory work.

UTILITY CONFLICTS

It shall be the responsibility of the Contractor to contact all affected utility owners and determine the precise locations of all utilities prior to beginning construction. Utility owners shall be contacted a minimum of 48 hours prior to the commencement of operations. Special care shall be used in working around or near existing utilities, protecting them when necessary to provide uninterrupted service. In the event that any utility service is interrupted, the Contractor shall notify the utility owner immediately and shall cooperate with the owner, or his representative, in the restoration of service in the shortest time possible. Existing fire hydrants shall be kept accessible to fire departments at all times.

The contractor shall adhere to all applicable regulations and follow accepted safety procedures when working in the vicinity of utilities in order to insure the safety of construction personnel and the public.

SUBSURFACE INFORMATION

(7-1-95)

450

SP1 G112 A

There is no subsurface information available on this project. The Contractor shall make his own investigation of subsurface conditions.

NOTIFICATION OF OPERATIONS

The Contractor shall notify the Engineer **5 calendar days** in advance of beginning work on this project. The Contractor shall give the Engineer sufficient notice of all operations for any sampling, inspection or acceptance testing required.

The Contractor shall request a pre-construction conference no later than 1 month after the date of availability. Contact Mr. Troy L. Baker (Assistant District Engineer) @ 910-486-1496.

MATERIAL AND EQUIPMENT STORAGE AND PARKING

When work is not in progress, keep all personnel, equipment, machinery, tools, construction debris and supplies at least 40 ft (12.2 m) away from active travel lanes. When vehicles, equipment, and materials are protected by concrete barrier or guardrail they should be offset a minimum of 5 ft (1.5 m) from the barrier or guardrail put along rear side.

RESPONSIBILITY FOR DAMAGE CLAIMS

In accordance with Article 107-14 of the Standard Specifications, the Contractor shall indemnify and save harmless the Department of Transportation and its officers, agents and employees from all suits, actions, or claims of any character brought for any injury or damages received or sustained by any person, persons or property by reason of any act of the Contractor, subcontractor, its agents or employees, in the performance of the contract. The Contractor further agrees to indemnify and save harmless the Department of Transportation and its officers, agents, and employees from any claims or amounts recovered by any of the Contractor's employees under the Worker's Compensation Act.

Pursuant to N.C.G.S. 97-19, all Contractors of the Department of Transportation are, prior to beginning services, required to show proof of coverage issued by a Worker's Compensation Insurance Carrier, or a Certificate of Compliance issued by the Department of Insurance for self-insured Subcontractors stating that it has complied with N.C.G.S. 97-93 irrespective of whether Subcontractors have regularly in service fewer than three employees in the same business within the State of North Carolina, and Subcontractors shall be hereinafter liable under the Worker's Compensation Act for payment of compensation and other benefits to its employees for any injury or death due to an accident arising out of, and in the course of performance of the work by, the Subcontractor.

VENDOR NUMBERS

ATTENTION CONTRACTORS:

Effective immediately, NCDOT will begin tracking the work of all subcontractors including DBE/MB/WB subcontractors. When the bids are prepared, all subcontractors, their vendor number and other information must be shown on the "Listing of Subcontractors" sheet found in the bid package. Most subcontractors have already been assigned a vendor number by the Raleigh office. If the subcontractor does not have an NCDOT vendor number, he/she must complete a W-9 form and may submit it to:

North Carolina Department of Transportation, Division 6 – District 2, Post Office Box 1150, Fayetteville, NC 28302.

Each time an invoice for payment is submitted to NCDOT, the prime contractor is required to submit a list of all subcontractors along with their vendor numbers that received payment the previous month from the prime contractor on the project. Also shown shall be the items of work they did and the amount paid to them the previous month and whether they were DBE/MB/WB. This list must be submitted along with the invoice in order for payment to be processed into the NCDOT accounting system. THE INVOICE CAN NOT BE PROCESSED NOR PAYMENT BE MADE UNTIL THIS INFORMATION IS SUBMITTED.

BANKRUPTCY

The Department of Transportation, at its option, may terminate the contract upon filing by the Contractor of any petition for protection under the provisions of the Federal Bankruptcy Act.

TRAFFIC CONTROL AND WORK ZONE SAFETY

The Contractor shall maintain traffic during construction and provide, install, and maintain all traffic control devices in accordance with these project guidelines, the Project Special Provisions, Division 11 of the North Carolina Department of Transportation Standard Specifications for Roads and Structures 2012, and the current edition of the Manual of Uniform Traffic Control Devices (MUTCD).

The Contractor shall utilize complete and proper traffic controls and traffic control devices during all operations. All traffic control and traffic control devices required for any operation shall be functional and in place prior to the commencement of that operation. Signs for temporary operations shall be removed during periods of inactivity. The Contractor is required to leave the project in a manner that will be safe to the traveling public and which will not impede motorists.

Traffic movements through lane closures on roads with two way traffic shall be controlled by flaggers stationed at each end of the work zone. In situations where sight distance is limited, the Contractor shall provide additional means of controlling traffic, including, but not limited to, two-way radios, pilot vehicles, or additional flaggers. Flaggers shall be competent personnel, adequately trained in flagging procedures, and furnished with proper safety devices and equipment, including, but not limited to, safety vests and stop/slow paddles.

All personnel when working in traffic areas or areas in close proximity to traffic shall wear an approved safety vest, or shirt or jacket which meets the color requirements of the Manual of Uniform Traffic Control Devices (MUTCD).

The Contractor shall comply with all applicable Federal, State, and local laws, ordinances, and regulations governing safety, health, and sanitation, and shall provide all safeguards, safety devices, and protective equipment, and shall take any other needed actions, on his own responsibility that are reasonably necessary to protect the life and health of employees on the job and the safety of the public, and to protect property in connection with the performance of the work covered by the contract.

Failure to comply with any of the requirements for safety and traffic control of this contract shall result in suspension of work as provided in subarticle 108-7 of the Standard Specifications.

All contractor personnel will be required to wear a Class II ANSI approved safety vest while working within the NCDOT Right of Way.

FLAGGERS

Furnish, relocate and maintain the flaggers, hats, vests, STOP/SLOW paddles and any other incidentals necessary to control traffic.

Refer to *Roadway Standard Drawings* No. 1150.01.

Provide the service of properly equipped and qualified flaggers (see *Roadway Standard Drawings* No. 1150.01) at locations and times for such period as necessary for the control and protection of vehicular and pedestrian traffic. Anyone who controls traffic is required to be qualified. Qualification consists of each flagger receiving proper training in the set-up and techniques of safely and competently performing a flagging operation. Qualification of flaggers is to be done by an NCDOT approved training agency or other approved training provider. For a complete listing of these, see the Work Zone Traffic Control's webpage. Prior to beginning work on the project, a Qualification Statement that all flaggers used on the project have been properly trained through an NCDOT approved training resource shall be provided to the Engineer.

Use flagging methods that comply with the guidelines in the MUTCD.

There shall be no direct payment for Flaggers as the use of Flaggers shall be considered incidental to the contractor's operations.

SUPERVISION BY CONTRACTOR

At all times during the life of the project the Contractor shall provide one permanent employee who shall have the authority and capability for overall responsibility of the project and who shall be personally available at the work site within 24 hours notice. Such employee shall be fully authorized to conduct all business with the subcontractors, to negotiate and execute all supplemental agreements, and to execute the orders or directions of the Engineer.

At all times that work is actually being performed, the Contractor shall have present on the project one competent individual who is authorized to act in a supervisory capacity over all work on the project, including work subcontracted. The individual who has been so authorized shall be experienced in the type of work being performed and shall be fully capable of managing, directing, and coordinating the work; of reading and thoroughly understanding the contract; and receiving and carrying out directions from the Engineer or his authorized representatives. He shall be an employee of the Contractor unless otherwise approved by the Engineer.

The Contractor may, at his option, designate one employee to meet the requirements of both positions. However, whenever the designated employee is absent from the work site, an authorized individual qualified to act in a supervisory capacity on the project shall be present.

LIABILITY INSURANCE

(5-20-14)

SP1 G160

Revise the *2012 Standard Specifications* as follows:

Page 1-60, Article 107-15 LIABILITY INSURANCE, line 16, add the following as the second sentence of the third paragraph:

Prior to beginning services, all contractors shall provide proof of coverage issued by a workers' compensation insurance carrier, or a certificate of compliance issued by the Department of Insurance for self-insured subcontractors, irrespective of whether having regularly in service fewer than three employees.

CONTRACT PAYMENT AND PERFORMANCE BOND

A performance bond in the amount of one hundred percent (100%) of the contract amount, conditioned upon the faithful performance of the contract in accordance with specifications and conditions of the contract is required for Construction contracts of \$500,000 or more. Such bond shall be solely for the protection of the North Carolina Department of Transportation and the State of North Carolina.

A payment bond in the amount of one hundred percent (100%) of the contract amount, conditioned upon the prompt payment for all labor or materials for which the Contractor, or his subcontractors, is liable is required for Construction contracts greater than \$500,000. The payment bond shall be solely for the protection of persons or firms furnishing materials or performing labor for this contract for which the Contractor is liable.

The successful bidder, within fourteen (14) days after notice of award, shall provide the Department with a contract payment bond and a contract performance bond each in an amount equal to 100 percent of the amount of the contract.

RETAINAGE AND PROMPT PAYMENT

Prompt Payment of Monies Due to Subcontractors, Second Tier Subcontractors and Material Suppliers and Release of Retainage

Contractors at all levels; prime, subcontractor, or second tier contractor, shall within seven calendar days of receipt of monies, resulting from work performed on the project or services rendered, pay subcontractors, second tier subcontractors, or material suppliers, as appropriate. This seven-day period begins upon knowledgeable receipt by the contracting firm obligated to make a subsequent periodic or final payment. These prompt payment requirements will be met if each firm mails the payment to the next level firm by evidence of postmark within the seven-day period.

This provision for prompt payment shall be incorporated into each subcontract or second tier subcontract issued for work performed on the project or for services provided.

The Contractor may withhold up to 3% retainage if any subcontractor does not obtain a payment and performance bond for their portion of the work. If any retainage is held on subcontractors, all retainage shall be released within seven calendar days of satisfactory completion of all work. For the purpose of release of retainage, satisfactory completion is defined as completion of all physical elements and corresponding documentation as defined in the contract, as well as agreement between the parties as to the final quantities for all work performed in the subcontract. The Department will provide internal controls to expedite the determination and processing of the final quantities for the satisfactorily completed subcontract portions of the project.

Failure of any entity to make prompt payment as defined herein may result in (1) withholding of money due to that entity in the next partial payment until such assurances are made satisfactory to this provision; or (2) removal of an approved contractor from the prequalified bidders list or the removal of other entities from the approved subcontractors list.

The Contractor shall submit a completed DBE-1S form with every invoice.

PARTIAL PAYMENT

The Contractor may submit a request for partial payment on a monthly basis, or other interval as approved by the Engineer. Compensation for all pay items shall be in accordance with the Standard Specifications. The amount of partial payments will be based on the work accomplished and accepted as the last day of the approved pay period. All requests for payment shall be made on the form furnished to the Contractor by the Department of Transportation. The form shall be completely and legibly filled out with all appropriate information supplied and shall be signed by an authorized representative of the Contractor. Minority Business (MB) and Women's Business (WB) participation shall be listed in the appropriate spaces on all requests for payment. If there is no participation the word "None" or the figure "0" shall be entered. An amount equal to five percent (5%) of the total amount due on the partial pay estimate will be deducted and retained until after the final inspection. One hundred percent (100%) payment shall be made after successful completion of the work as verified by the final inspection.

The Contractor shall submit a completed DBE-1S form with every invoice. Invoices shall not be processed until the completed DBE-IS form has been received by the District Engineer or his/her representative.

CLAIMS FOR ADDITIONAL COMPENSATION OR EXTENSION OF TIME

Any claims for additional compensation and/or extensions of the completion date shall be submitted to the Division Engineer with detailed justification within thirty (30) days after receipt of the final invoice payment. The failure of the Contractor to submit the claim(s) within thirty days shall be a bar to recovery.

INVOICES FOR PAYMENT

The Contractor shall submit an invoice to the District Engineer for approval for payment. For any discrepancies noted on the invoice, the Contractor will be notified to submit a corrected copy before payment can be made (No errors or strike-thrus are permitted).

Scheduled estimate times will be determined by the District Engineer during the pre-construction conference. No invoices shall be accepted for payment at any time other than those scheduled, unless directed by the Engineer. For final invoice payment, a separate invoice will be submitted for any retainage due.

THE FINAL INVOICE SHALL BE RECEIVED IN THE DISTRICT ENGINEER'S OFFICE WITHIN ONE (1) WEEK OF THE COMPLETION DATE.

Invoices shall be submitted to:

Mr. Troy L. Baker
NCDOT – Division of Highways
PO Box 1150
Fayetteville, NC 28306

OUTSOURCING OUTSIDE THE USA

(9-21-04) (5-16-06)

SP1G150

All work on consultant contracts, services contracts, and construction contracts shall be performed in the United States of America. No work shall be outsourced outside of the United States of America.

Outsourcing for the purpose of this provision is defined as the practice of subcontracting labor, work, services, staffing, or personnel to entities located outside of the United States.

The North Carolina Secretary of Transportation shall approve exceptions to this provision in writing.

MAINTENANCE OF THE PROJECT

(11-20-07) (Rev. 1-17-12)

104-10

SP1 G125

Revise the *2012 Standard Specifications* as follows:

Page 1-35, Article 104-10 Maintenance of the Project, line 25, add the following after the first sentence of the first paragraph:

All guardrail/guiderail within the project limits shall be included in this maintenance.

Page 1-35, Article 104-10 Maintenance of the Project, line 30, add the following as the last sentence of the first paragraph:

The Contractor shall perform weekly inspections of guardrail and guiderail and shall report damages to the Engineer on the same day of the weekly inspection. *Where damaged guardrail or guiderail is repaired or replaced as a result of maintaining the project in accordance with this article, such repair or replacement shall be performed within 7 consecutive calendar days of such inspection report.*

Page 1-35, Article 104-10 Maintenance of the Project, lines 42-44, replace the last sentence of the last paragraph with the following:

The Contractor will not be directly compensated for any maintenance operations necessary, except for maintenance of guardrail/guiderail, as this work will be considered incidental to the work covered by the various contract items. The provisions of Article 104-7, Extra Work, and Article 104-8, Compensation and Record Keeping will apply to authorized maintenance of guardrail/guiderail. Performance of weekly inspections of guardrail/guiderail, and the damage reports required as described above, will be considered to be an incidental part of the work being paid for by the various contract items.

TWELVE MONTH GUARANTEE

(7-15-03)

108

SP1 G145

- (A) The Contractor shall guarantee materials and workmanship against latent and patent defects arising from faulty materials, faulty workmanship or negligence for a period of twelve months following the date of final acceptance of the work for maintenance and shall replace such defective materials and workmanship without cost to the Department. The Contractor will not be responsible for damage due to faulty design, normal wear and tear, for negligence on the part of the Department, and/or for use in excess of the design.
- (B) Where items of equipment or material carry a manufacturer's guarantee for any period in excess of twelve months, then the manufacturer's guarantee shall apply for that particular piece of equipment or material. The Department's first remedy shall be through the manufacturer although the Contractor is responsible for invoking the warranted repair work with the manufacturer. The Contractor's responsibility shall be limited to the term of the manufacturer's guarantee. NCDOT would be afforded the same warranty as provided by the Manufacturer.

This guarantee provision shall be invoked only for major components of work in which the Contractor would be wholly responsible for under the terms of the contract. Examples would include pavement structures, bridge components, and sign structures. This provision will not be used as a mechanism to force the Contractor to return to the project to make repairs or perform additional work that the Department would normally compensate the Contractor for. In addition, routine maintenance activities (i.e. mowing grass, debris removal, ruts in earth shoulders,) are not parts of this guarantee.

Appropriate provisions of the payment and/or performance bonds shall cover this guarantee for the project.

To ensure uniform application statewide the Division Engineer will forward details regarding the circumstances surrounding any proposed guarantee repairs to the Chief Engineer for review and approval prior to the work being performed.

MATERIALS AND TESTING

The Engineer reserves the right to perform all sampling and testing in accordance with Section 106 of the Standard Specifications and the Department's "Materials and Test Manual." However the Engineer may reduce the frequency of sampling and testing where he deems it appropriate for the project.

The Contractor shall furnish the applicable certifications and documentation for all materials as required by the Standard Specifications. Material, which is not properly certified, will not be accepted.

INSPECTION

All work shall be subject to inspection by the Engineer at any time. Routinely, the Engineer will make periodic inspections of the completed work. It will be the responsibility of the Contractor to keep the Engineer informed of his proposed work plan and to submit written reports of work accomplished on a frequency to be determined by the Engineer.

ENGINEERING CONTROL

Engineering control and inspection will be by the North Carolina Department of Transportation. The Contractor will cut test samples as directed by the Engineer. The North Carolina Department of Transportation will set all necessary grades for pipe, ditches, or masonry drainage structures. All other field engineering will be the responsibility of the Contractor and considered as incidental to the project bid.

DEBARMENT STATEMENT

The Contractor certifies and understands that by his/her signature on the Bid Form that he/she and the contracting firm he/she represents has not been banned, debarred, suspended, proposed for debarment, or declared ineligible for the award of contracts by any Federal agency.

GIFTS FROM VENDORS AND CONTRACTORS

(12-15-09)

107-1

SP1 G152

By Executive Order 24, issued by Governor Perdue, and *N.C.G.S. § 133-32*, it is unlawful for any vendor or contractor (i.e. architect, bidder, contractor, construction manager, design professional, engineer, landlord, offeror, seller, subcontractor, supplier, or vendor), to make gifts or to give favors to any State employee of the Governor's Cabinet Agencies (i.e. Administration, Commerce, Correction, Crime Control and Public Safety, Cultural Resources, Environment and Natural Resources, Health and Human Services, Juvenile Justice and Delinquency Prevention, Revenue, Transportation, and the Office of the Governor). This prohibition covers those vendors and contractors who:

- (A) Have a contract with a governmental agency; or
- (B) Have performed under such a contract within the past year; or
- (C) Anticipate bidding on such a contract in the future.

For additional information regarding the specific requirements and exemptions, vendors and contractors are encouraged to review Executive Order 24 and *N.C.G.S. § 133-32*.

Executive Order 24 also encouraged and invited other State Agencies to implement the requirements and prohibitions of the Executive Order to their agencies. Vendors and contractors should contact other State Agencies to determine if those agencies have adopted Executive Order 24.

INDEMNIFICATION

The Contractor shall defend, indemnify and hold harmless the North Carolina Department of Transportation, its officers and employees from any claim, demand, suit, liability, judgement and expense (including attorney's fees and other costs of litigation) arising out of or relating to injury, disease, or death of persons or damage to or loss of property resulting from or in connection with the negligent performance of this contract by the Contractor, its agents, employees, and subcontractors or any one for whom the Contractor may be responsible. The obligations, indemnities and liabilities assumed by the Contractor under this paragraph shall not extend to any liability caused by the negligence of the Department of Transportation or its employees. The Contractor's liability shall not be limited by any provisions or limits of insurance set forth in this contract.

The Contractor shall indemnify and hold harmless the Department of Transportation from any claim, demand, suit, liability, judgement, and expense involving damage or loss to the Contractor's equipment (including vandalism, theft, fire, and acts of God) arising out of or relating to work performed under this agreement. The obligations, indemnities and liabilities assumed by the Contractor under this paragraph shall not extend to any liability caused by the negligence of the Department of Transportation or its employees. The Contractor's liability shall not be limited by any provisions or limits of insurance set forth in this contract.

The Contractor further agrees to indemnify the Department of Transportation for any damages to the roadway, highway signs, highway equipment and other property owned or in possession of the Department of Transportation, brought about by reason of the negligent operation of the equipment. The Contractor further agrees to indemnify and save harmless the Department of Transportation, its officers and employees from any claims or amounts recovered by any of the Contractor's employees under the Workmen's Compensation Act.

CONTACTOR CLAIM SUBMITTAL FORM

If the Contractor elects to file a written claim or requests an extension of contract time, it shall be submitted on the *Contractor Claim Submittal Form (CCSF)* available through the Construction Unit or http://ncdot.org/doh/operations/dp_chief_eng/constructionunit/formsmanuals/.

AVAILABILITY OF FUNDS – TERMINATION OF CONTRACTS

(5-20-08)

Z-2

General Statute 143C-6-11. (h) Highway Appropriation is hereby incorporated verbatim in this contract as follows:

(h) Amounts Encumbered. – Transportation project appropriations may be encumbered in the amount of allotments made to the Department of Transportation by the Director for the estimated payments for transportation project contract work to be performed in the appropriation fiscal year. The allotments shall be multiyear allotments and shall be based on estimated revenues and shall be subject to the maximum contract authority contained in *General Statute 143C-6-11(c)*. Payment for transportation project work performed pursuant to contract in any fiscal year other than the current fiscal year is subject to appropriations by the General Assembly. Transportation project contracts shall contain a schedule of estimated completion progress, and any acceleration of this progress shall be subject to the approval of the Department of Transportation provided funds are available. The State reserves the right to terminate or suspend any transportation project contract, and any transportation project contract shall be so terminated or suspended if funds will not be available for payment of the work to be performed during that fiscal year pursuant to the contract. In the event of termination of any contract, the contractor shall be given a written notice of termination at least 60 days before completion of scheduled work for which funds are available. In the event of termination, the contractor shall be paid for the work already performed in accordance with the contract specifications.

Payment will be made on any contract terminated pursuant to the special provision in accordance with Article 108-13(E), of the *North Carolina Department of Transportation Standard Specifications for Roads and Structures*, dated July 1, 2012.

DEFAULT OF CONTRACT

The Department of Transportation shall have the right to declare default of contract for breach by the Contractor of any material term or condition of the contract. Default of contract shall be in accordance with the terms, conditions, and procedures of Article 108-9 of the Standard Specifications.

EMPLOYMENT

(11-15-11) (Rev. 1-17-12)

108, 102

SP1 G184

Revise the *2012 Standard Specifications* as follows:

Page 1-20, Subarticle 102-15(O), delete and replace with the following:

(O) Failure to restrict a former Department employee as prohibited by Article 108-5.

Page 1-65, Article 108-5 Character of Workmen, Methods, and Equipment, line 32, delete all of line 32, the first sentence of the second paragraph and the first word of the second sentence of the second paragraph.

DIVISION CONTRACT

Project Special Provisions

NOTIFICATION OF OPERATIONS

The Contractor shall notify the Engineer **one week** in advance of beginning work on this project. The Contractor shall give the Engineer sufficient notice of all operations for any sampling, inspection or acceptance testing required.

INTERPRETATION OF QUANTITIES IN PROPOSAL FORM

The quantities appearing in the proposal form are approximate only and are to be used for the comparison of bids. Payment to the Contractor will be made only for the actual quantities of the various items that are completed and accepted in accordance with the terms of the contract.

DRIVEWAYS AND PRIVATE PROPERTY

The Contractor shall maintain access to driveways for all residents and property owners throughout the life of the project. The Contractor shall not perform work for private citizens or agencies in conjunction with this project or within the project limits of this contract. Any driveway paved by a Contractor which ties into a NCDOT system road being paved by the Contractor must be paved either prior to the road paving project or after its completion. Any driveway cut or damaged by the contractor shall be repaired. Driveway construction will include the removal, disposal and regrading of the driveways for a distance necessary as directed by the Engineer. Concrete or asphalt driveway removal will require a saw cut. There shall be no direct payment for driveway construction.

TRAFFIC SIGNS & MAILBOXES

Permanent traffic signs and mailboxes that interfere with the road construction operations are to be removed during the course of a day's work, and be reinstalled at the conclusion of each work day. The Contractor shall mark the proper location of the signs and mailboxes by placing an offset stake behind the ditch line to ensure proper replacement.

EQUIPMENT

The Contractor shall furnish all equipment in good operating condition and operated by properly trained and qualified personnel. The Contractor shall be responsible for all costs or charges incurred in the operation and maintenance of the equipment during the performance of this contract. Upon request, the contractor shall provide any and all state and federal certifications for equipment safety.

Payment for equipment and labor required to perform bid items is included in the bid item price provided by the contractor. Mobilization of labor and equipment shall be included in the bid item price provided by the contractor.

MOBILIZATION

This work consists of preparatory work and operations, including but not limited to the movement of personnel, equipment, supplies, and incidentals to the project site, for the establishment of offices, buildings, and other facilities necessary for work on the project; the removal and disbandment of those personnel, equipment, supplies, incidentals, or other facilities that were established for the prosecution of work on the project; and for all other work and operations which must be performed for costs incurred prior to beginning work on the various items on the project site.

Basis of payment:
Mobilization will be lump sum.

WASTE AND BORROW SOURCES

Payment for temporary erosion control measures, except those made necessary by the Contractor's own negligence or for his own convenience, will be paid for at the appropriate contract unit price for the devices or measures utilized in borrow sources and waste areas. No additional payment will be made for erosion control devices or permanent seeding and mulching in any commercial borrow or waste pit. All erosion and sediment control practices that may be required on a commercial borrow or waste site will be done at the Contractor's expense. All waste/debris including but not limited to spoil material, vegetation, concrete, asphalt, and culverts shall not be removed from the project until all waste sites have identified and approved by the Engineer and the Division Environmental Officer. **All waste/debris removed from the project shall be disposed of at the approved waste site.**

All waste shall be disposed of at a site that has an Environmental Assessment approved by the Division Environmental Officer. Work shall not begin on this project until such time as the source of waste and borrow along with the submission of all applicable permits have been identified and approved by the Engineer and the Division Environmental Officer. For additional information in regards to the requirement of the Environmental Assessment, contact the Division Six Environmental Officer @ (910) 437-0207.

UNDERCUT EXCAVATION

When the Engineer determines that the finish graded roadway cross section contains undesirable material, the Contractor shall remove the material and backfill with suitable, properly compacted material. Payment for undercut excavation will be made only in areas that have been examined and approved by the Engineer. Work shall be done in accordance with Section 225 of the Standard Specifications.

Excavation will be measured and paid in cubic yards of materials, measured in their original position and computed by the average end method. The Contractor shall not exceed a depth of three (3) feet when excavating unsuitable material. Foundation Conditioning Geotextile (Geotextile for Drainage, Type 2) shall be utilized in these areas or as directed by the Engineer. All excess material shall be disposed of in accordance with Section 802 of the Standard Specifications.

Payment to the contractor will be full compensation for all work involving undercut excavation and hauling and disposing of materials.

Basis of payment:

Undercut Excavation, per cubic yard,

Geotextiles for Drainage, Type 2, per square yard (Contingent Item).

BORROW MATERIAL

Borrow Excavation shall be done in accordance with Section 230 and 1018 of the Standard Specifications. Excavate approved material from borrow sources. Haul and use such material as required in the plans or as directed. Do not use borrow excavation until all available suitable excavation has been incorporated into the affected area(s).

The borrow material used on this project will be measured for payment by truck measurement as provided in Article 230-5(B) of the Standard Specifications.

During construction and until final acceptance, use any methods approved by the Engineer that are necessary to maintain the work covered by this section so that the work will not contribute to excessive soil erosion.

Borrow Material used for shoulder and slope areas shall meet the requirements as stipulated in the Shoulder and Slope Borrow provision below.

Basis of payment:
Borrow Material, per cubic yard.

SHOULDER AND SLOPE BORROW

(3-19-13)

1019

SP10 R10

Use soil in accordance with Section 1019 of the *2012 Standard Specifications*. Use soil consisting of loose, friable, sandy material with a PI greater than 6 and less than 25 and a pH ranging from 5.5 to 7.0.

Soil with a pH ranging from 4.0 to 5.5 will be accepted without further testing if additional limestone is provided in accordance with the application rates shown in Table 1019-1A. Soil type is identified during the soil analysis. Soils with a pH above 7.0 require acidic amendments to be added. Submit proposed acidic amendments to the Engineer for review and approval. Soils with a pH below 4.0 or that do not meet the PI requirements shall not be used.

TABLE 1019-1A			
ADDITIONAL LIMESTONE APPLICATION RATE TO RAISE pH			
pH TEST RESULT	Sandy Soils Additional Rate (lbs. / Acre)	Silt Loam Soils Additional Rate (lbs. / Acre)	Clay Loam Soils Additional Rate (lbs. / Acre)
4.0 - 4.4	1,000	4,000	6,000
4.5 - 4.9	500	3,000	5,000
5.0 - 5.4	NA	2,000	4,000

Note: Limestone application rates shown in this table are in addition to the standard rate of 4000 lbs. / acre required for seeding and mulching.

No direct payment will be made for providing additional lime or acidic amendments for Ph adjustment.

Basis of payment:
Borrow Material, per cubic yard.

SELECT MATERIAL

Furnish and place select material in accordance with the contract or as directed by the Engineer. Select material is suitable material classified by gradation and performance characteristics as shown in Section 1016 of the Standard Specifications. Use select material called for on the contract for backfill in undercut and pipe backfill in locations specified by the Engineer and in accordance with Section 300-7 of the Standard Specifications. With written approval and without additional compensation, a higher class of material may be substituted than stated in the contract. Use Class II or III Select Material. Refer to Division 10 of the Standard Specifications.

Item	Section
Select Material, Class II	1016
Select Material, Class III	1016

There shall be no direct payment for Select Material as the placement of the Select Material shall be considered incidental to the installation the Pipe Culverts.

SELECT GRANULAR MATERIAL

(3-16-10) (Rev. 1-17-12)

265

SP2 R80

Revise the *2012 Standard Specifications* as follows:

Page 2-28, Article 265-2 MATERIALS, add the following:

Use only Class III select material for select granular material.

Page 2-28, Article 265-4 MEASUREMENT AND PAYMENT, lines 13-30, replace all occurrences of *Select Granular Material* with *Select Granular Material, Class III*.

SELECT MATERIAL, CLASS III, TYPE 3

(1-17-12)

1016, 1044

SP10 R05

Revise the *2012 Standard Specifications* as follows:

Page 10-39, Article 1016-3, CLASS III, add the following after line 14:

Type 3 Select Material

Type 3 select material is a natural or manufactured fine aggregate material meeting the following gradation requirements and as described in Sections 1005 and 1006:

Percentage of Total by Weight Passing							
3/8"	#4	#8	#16	#30	#50	#100	#200
100	95-100	65-100	35-95	15-75	5-35	0-25	0-8

Page 10-39, Article 1016-3, CLASS III, line 15, replace “either type” with “Type 1, Type 2 or Type 3”.

Page 10-62, Article 1044-1, line 36, delete the sentence and replace with the following:

Subdrain fine aggregate shall meet Class III select material, Type 1 or Type 3.

Page 10-63, Article 1044-2, line 2, delete the sentence and replace with the following:

Subdrain coarse aggregate shall meet Class V select material.

FOUNDATION CONDITIONING MATERIAL

This item shall be of number 5 or number 57 stone. It shall be in accordance with Sections 300 and 1016 of the Standard Specifications. It will also be in accordance with standard drawing number 300.01 of the Roadway Standards Drawings. This item will be utilized at locations where the existing foundation material is unsuitable for the installation of pipe and at any other locations so designated by the Engineer. Loosely place bedding material, in a uniform layer, a depth equal to the inside diameter of the pipe divided by 6 or 6 inches, whichever is greater. Leave bedding material directly beneath the pipe uncompacted and allow pipe seating and backfill to accomplish compaction.

Payment to the contractor will be full compensation for all work involving pipe bedding, including all pipe undercut excavation, placing pipe bedding material, shaping the pipe foundation and hauling and disposing of materials.

Basis of Payment:

Foundation Conditioning Material, per ton (Contingent Item).

PIPE CULVERTS

The Contractor shall furnish and install pipe culverts in accordance with the requirements of Division 3 of the Standard Specifications, standard drawing number 300.01 of the Roadway Standards Drawings, and amendments thereof and as directed by the Engineer. The work includes construction of joints and connections to other pipes, endwalls, and drainage structures.

All cross pipes shall be constructed with minimum cover as defined the Standard Specifications, Standard Drawing numbers 300.01 of the Roadway Standards Drawings, the Roadway Design Manual, and amendments thereof and as directed by the Engineer. All pipe materials shall be inspected and approved by the Engineer after delivery to the project and prior to installation.

The Contractor shall thoroughly and carefully backfill the pipe in layers not exceeding 6 inches loose with material approved by the Engineer. Pipe and backfilled areas shall be graded and maintained in such a condition that erosion or saturation will not erode or damage the pipe or backfill. Compact to the density required by Subarticle 235-3(C). Approval of the backfill material is required before its use. Use select material as shown in the contract documents. Heavy equipment shall not be operated over the pipe until it has been properly backfilled and minimum cover as shown on the plans or as approved by the Engineer has been placed over the pipe. **Pipe culverts shall not be backfilled until approved by the Engineer or his representative.**

Do not waste excavation unless permitted. Use suitable excavated material as backfill; or in the formation of embankments, subgrades, and shoulders; or as otherwise directed. Furnish disposal areas for the unsuitable material. The Engineer will identify excavated materials that are unsuitable. Provide bedding material in accordance with Article 1016-3 for Class II (Type 1 only) or Class III select material as shown in contract. **No measurement will be made for select bedding and select backfill material required in the contract documents. The select bedding and backfill material will be included in the cost of the installed pipe.**

Where traffic is to be maintained, install pipe in sections so that half the width of the roadway is available to traffic.

Where material is found to be of poor supporting value or of rock and when the Engineer cannot make adjustment in the location of the pipe, undercut existing foundation material within the limits established on the plans. Backfill the undercut with select bedding and backfill material or foundation conditioning material as conditions permit. Where foundation conditioning geotextiles are required for soil stabilization, use Geotextiles for Drainage, Type 2 or as directed by the Engineer.

PIPE CULVERTS (continued)

If proposed invert elevations are adjusted and/or the actual location of a pipe culvert is changed from the location on the plans during construction based upon actual conditions encountered, no claim for an extension of time for any reason resulting from this information will be allowed.

Pipe will be measured and paid as the actual number of linear feet of pipe that has been incorporated into the completed and accepted work. Measurement of pipe will be made by counting the number of joints used and multiplying by the length of the joint to obtain the number of linear feet of pipe installed and accepted. Measurements of partial joints will be made along the longest length of the partial joint to the nearest 0.1 foot.

A copy of the environmental permits shall be onsite during construction activities. Any violation of the permits could result in fines. The Division Environmental Officer and/or his representative shall be on site during the placement of the 2 – 24” RC Pipe Culverts, Class III. A minimum of 24 hours notification prior to the placement of the 2 – 24” RC Pipe Culverts, Class III shall be considered mandatory.

Where traffic is to be maintained, install pipe in sections so that half the width of the roadway is available to traffic unless otherwise approved by the engineer.

Basis of payment:

15” RC Pipe Culverts, Class III, per linear foot,

18” RC Pipe Culverts, Class III, per linear foot,

24” RC Pipe Culverts, Class III, per linear foot,

Dewatering, per each,

Geotextiles for Drainage, Type 2, per square yard (Contingent Item).

PIPE REMOVAL

All pipe removal will be considered waste material, and will be the responsibility of the Contractor to remove to the waste site. Payment will be per unit price and include removal to the waste site.

Removal of drainage structures such as head walls will be considered incidental to the pipe removal. Pipe Removal shall be done in accordance with Section 340 of the Standard Specifications.

Contract unit price bid shall include removal to, and disposal at, a Contractor provided waste site.

Basis of payment:

Pipe Removal, per linear foot.

COMPREHENSIVE GRADING

The Contractor is to grade this project to the typical sections, details, and plans provided. Horizontal curves shall be super elevated at a rate of 0.25 in per foot to the inside of the curve and shall be transitioned from the typical section one hundred feet (100') before the point of curvature (PC) and one hundred feet (100') after the point of tangency (PT) or as directed by the Engineer.

Grading shall be comprehensive grading as defined in Section 226 of the Standard Specifications, as amended herein, and shall include all grading work necessary to construct the project including but not limited to clearing and grubbing (right of ways and sight distances), roadway excavation (channeling), embankment construction, shoulder construction, fine grading, and shaping, grading and compacting roadway ditches, tail ditches, slopes and subgrade. This item will also include grading any abandoned roadway to conform with the surrounding land contours as well as pulling the shoulders up to the new edge of pavement. **The clearing and grubbing within the right of way, in accordance with Section 200 of the Standard Specifications shall be completed by the Intermediate Completion date.**

Driveway construction will include the removal, disposal and regrading of the driveways for a distance necessary as directed by the Engineer. Concrete or asphalt driveway removal will require a saw cut.

It will be the Contractor's responsibility to dispose of any waste material. Borrow excavation will be covered under a separate item. However, all suitable excess material shall be stockpiled and used for shoulder material. **No material may be wasted or removed from the project unless approved by the Engineer.** Any material removed from the project shall be done in accordance with Section 802 of the Standard Specifications. **All waste/debris removed from the project shall be disposed of at the approved waste site.**

All waste shall be disposed of at a site that has an Environmental Assessment approved by the Division Environmental Officer. Work shall not begin on this project until such time as the source of waste and borrow along with the submission of all applicable permits have been identified and approved by the Engineer and the Division Environmental Officer. For additional information in regards to the requirement of the Environmental Assessment, contact the Division Six Environmental Officer @ (910) 437-0207.

The Contractor shall shape, compact and grade the slopes, ditches, subgrade and shoulders to the lines, grades and typical sections established by the plans or as directed by the Engineer. Roadway ditches shall be cleaned, reshaped and maintained until final acceptance of the project. Drainage adequate for the protection of the subgrade shall be provided at all times. Previously approved subgrade that is damaged by natural causes, construction equipment, hauling equipment or traffic shall be restored to the required lines, grades, typical sections and densities at no expense to the Department of Transportation.

Excavated areas shall be uniformly graded, well compacted and free of debris and loose material. Excavated areas adjacent to existing pavement having more than a 2 inch drop from the edge of pavement shall not be left open overnight. Such areas shall be made safe by the placement of solid material at a 6:1 or flatter slope. All open areas shall be identified and guarded by adequate traffic control devices as directed and approved by the Manual of Uniform Traffic Control Devices (MUTCD), North Carolina Department of Transportation Roadway Standard Drawings, and the Engineer.

The Contractor shall remove and satisfactorily dispose of vegetation and debris from within the project limits. All waste shall be disposed in accordance with state, federal and local regulations regarding the disposal of waste material and Section 802 of the Standard Specifications. All permits and fees for any such disposal shall be the responsibility of the Contractor. NCDOT shall not be held liable for disposal of any materials outside the project right of way.

Basis of payment:

Clearing and Grubbing (Intermediate Completion Date) will be lump sum,
Comprehensive Grading will be lump sum.

AGGREGATE BASE COURSE

(11-18-14)

520

SP5 R14

Revise the *2012 Standard Specifications* as follows:

Page 5-10, Article 520-5 HAULING AND PLACING AGGREGATE BASE MATERIAL, add the following sentence to the end of the first paragraph starting on line 21:

In addition, as approved by the Engineer, place by end dumping aggregate on approved sandy subgrade soils to provide a working platform and reduce wheel rutting of the subgrade. When allowed, end dumping will be limited to a uniformly spread thickness of 2 to 3 inches prior to placing the remaining aggregate thickness with a mechanical spreader.

The Contractor shall furnish and place aggregate base course in accordance with the provisions of Section 520 of the *Standard Specifications* and to the typical sections and details shown. **This item shall be placed with a box spreader.** The Contractor shall dry or add moisture to the material when required to provide a uniformly compacted and acceptable base. When completed, the base course shall be smooth, hard, dense, unyielding and well bonded. The roadway shall be proof-rolled prior to placing asphalt.

Payment will be made under the item "Aggregate Base Course" and shall include, but not be limited to, furnishing aggregate with water, mixing, hauling, spreading materials, compacting, shaping and maintaining the base course.

Basis of payment:

Aggregate Base Course, per ton.

INCIDENTAL STONE BASE

(7-1-95) (Rev.8-21-12)

545

SP5 R28R

Description

Place incidental stone base on driveways, mailboxes, etc. immediately after paving and do not have the paving operations exceed stone base placement by more than one week without written permission of the Engineer.

Materials and Construction

Provide and place incidental stone base in accordance with Section 545 of the *2012 Standard Specifications*.

Measurement and Payment

Incidental Stone Base will be measured and paid in accordance with Article 545-6 of the *2012 Standard Specifications*.

Basis of payment:

Incidental Stone Base, per ton.

ASPHALT BINDER

The quantity of asphalt binder to be paid will be the theoretical number of tons required by the job mix formula. **The contractor shall furnish the Engineer with documentation supporting the amount of asphalt binder used in the approved job mix formula for this project when invoicing for payment.**

Basis of payment:
Asphalt Binder, PG 64-22, per ton.

ASPHALT BINDER CONTENT OF ASPHALT PLANT MIXES

(11-21-00) (Rev. 7-17-12)

609

SP6 R15

The approximate asphalt binder content of the asphalt concrete plant mixtures used on this project will be as follows:

Asphalt Concrete Base Course	Type B 25.0__	4.4%
Asphalt Concrete Intermediate Course	Type I 19.0__	4.8%
Asphalt Concrete Surface Course	Type S 4.75A	6.8%
Asphalt Concrete Surface Course	Type SA-1	6.8%
Asphalt Concrete Surface Course	Type SF 9.5A	6.7%
Asphalt Concrete Surface Course	Type S 9.5__	6.0%
Asphalt Concrete Surface Course	Type S 12.5__	5.6%

The actual asphalt binder content will be established during construction by the Engineer within the limits established in the *2012 Standard Specifications*.

PRICE ADJUSTMENT - ASPHALT BINDER FOR PLANT MIX

(11-21-00)

620

SP6 R25

Price adjustments for asphalt binder for plant mix will be made in accordance with Section 620 of the Standard Specifications as modified herein.

The base price index for asphalt binder for plant mix is **\$483.08** per ton.

This base price index represents an average of F.O.B. selling prices of asphalt binder at supplier's terminals on May 1, 2015.

QUALITY MANAGEMENT SYSTEM - ASPHALT PLANT MIX PAVEMENTS

The production and construction of all asphalt mixtures and pavements shall be in accordance with the quality management system (QMS) as described in Section 609 of the Standard Specifications. This shall include all work specified in Section 609 of the Standard Specifications including field laboratory, all labor, tools, equipment, sampling, testing, record keeping, and incidentals necessary to complete the work.

No direct payment will be made for QMS. The cost of this work shall be included in the contract unit price per ton for Asphalt Concrete Surface Course, Type SF 9.5 A.

PAVING

The production, delivery, placement, and compaction of all bituminous material shall be in accordance with Section 610 of the Standard Specifications. A currently approved North Carolina Department of Transportation job mix formula shall be used for all bituminous construction.

The air temperature 48 continuous hours prior to paving must be above 32 degrees Fahrenheit. Air temperature at the time of paving shall be in accordance with Subarticle 610-4 of the Standard Specifications.

The Contractor shall compact the bituminous material on this project in accordance with Subarticle 610-9 of the Standard Specifications and the following provision:

Compact all final wearing surfaces using a minimum of two (2) steel wheel rollers, unless otherwise approved. Pneumatic-tired rollers with 2 tandem axles and smooth tread tires may be used for intermediate rolling.

Pavement shall not be placed until the base has been approved by the Engineer or his representative. A North Carolina Department of Transportation inspector shall be present during the placement of bituminous material.

The Contractor shall use a stringline or other approved method to establish a uniform consistent line to locate the edge of pavement. It shall be the Contractor's responsibility to place such line, but it shall meet the approval of the Engineer or his representative.

A smooth joint shall be provided at paved driveways. The Contractor shall exercise caution when operating equipment at paved residential drives in order to avoid pavement damage. An apron or turnout will be required at unpaved driveways.

The item of Asphalt Concrete Surface Course Type SF9.5 A (in place) will include furnishing and placing of Asphalt Concrete Surface Course Type SF9.5 A in accordance with the typical section, Section 610 of the Standard Specifications and an approved job mix formula along with the saw cutting of the existing pavement where applicable. Paving operations will also include 2 foot widening along the inside curve radius from a point **100 ft. before the PC station** to a point **100 ft. after the PT station** per attached detail, and 2 foot driveway turnouts, to match existing driveway widths as directed by the Engineer or his representative.

Basis of payment:

Asphalt Concrete Surface Course Type SF 9.5 A, per ton.

PAVEMENT QUANTITIES

SR #	FROM	TO	WIDTH	LENGTH	TONS ACSC TYPE SF 9.5 A
SR 2309	SR 1779	End of Maintenance Limits	20'	0.31 mile	340

ASPHALT PAVEMENTS - WARM MIX ASPHALT SUPERPAVE

Warm Mix Asphalt (WMA) is defined as additives or processes that allow a reduction in the temperature at which asphalt mixtures are produced and placed.

Notify the Engineer at least 2 weeks before producing the WMA so the Engineer can arrange a pre-pave meeting. Discuss special testing requirements necessary for WMA at the pre-pave meeting. Include at the pre-pave meeting the Contractor's QC manager, Paving Superintendent, and manufacturer's representative for the WMA technology, the Department's Roadway Construction Engineer, District Engineer, State Pavement Construction Engineer, and Quality Assurance Supervisor.

Require a manufacturer's representative for the WMA technology used to be present on site at the plant during the initial production and on the roadway during the laydown of the warm mix asphalt.

The requirement for the manufacturer's representative to be present at the pre-pave meeting and on-site at the plant may be waived by the Engineer based on previous work experience with the specific WMA technology used.

If the use of WMA is suspended during production, and the Contractor begins using Hot Mix Asphalt (HMA), then the Contractor shall be required to use HMA for the remainder of the specific route or map unless otherwise approved by the Engineer.

PAVEMENT MARKINGS

Pavement markings will be installed by North Carolina Department of Transportation forces.

ASPHALT PAVEMENTS - SUPERPAVE

(6-19-12) (Rev. 4-21-15)

605, 609, 610, 650

SP6 R01

Revise the 2012 Standard Specifications as follows:

Page 6-3, Article 605-7 APPLICATION RATES AND TEMPERATURES, replace this article, including Table 601-1, with the following:

Apply tack coat uniformly across the existing surface at target application rates shown in Table 605-1.

TABLE 605-1 APPLICATION RATES FOR TACK COAT	
Existing Surface	Target Rate (gal/sy)
	Emulsified Asphalt
New Asphalt	0.04 ± 0.01
Oxidized or Milled Asphalt	0.06 ± 0.01
Concrete	0.08 ± 0.01

Apply tack coat at a temperature within the ranges shown in Table 605-2. Tack coat shall not be overheated during storage, transport or at application.

TABLE 605-2 APPLICATION TEMPERATURE FOR TACK COAT	
Asphalt Material	Temperature Range
Asphalt Binder, Grade PG 64-22	350 - 400°F
Emulsified Asphalt, Grade RS-1H	130 - 160°F
Emulsified Asphalt, Grade CRS-1	130 - 160°F
Emulsified Asphalt, Grade CRS-1H	130 - 160°F
Emulsified Asphalt, Grade HFMS-1	130 - 160°F
Emulsified Asphalt, Grade CRS-2	130 - 160°F

Page 6-7, Article 609-3 FIELD VERIFICATION OF MIXTURE AND JOB MIX FORMULA ADJUSTMENTS, lines 35-37, delete the second sentence of the second paragraph.

Page 6-18, Article 610-1 DESCRIPTION, lines 40-41, delete the last sentence of the last paragraph.

Page 6-19, Subarticle 610-3(A) Mix Design-General, line 5, add the following as the first paragraph:

Warm mix asphalt (WMA) is allowed for use at the Contractor's option in accordance with the NCDOT Approved Products List for WMA Technologies available at:

<https://connect.ncdot.gov/resources/Materials/MaterialsResources/Warm%20Mix%20Asphalt%20Approved%20List.pdf>

UTILITY CONSTRUCTION

All proposed utility construction shall meet the applicable requirements of the current NC Department of Transportation's Standard Specifications for Roads and Structures or amendments thereof. Division 15 of the Standard Specifications is revised as follows:

Page 15-1, Paragraph 4

Provide access for Department personnel and the owner's representatives to all phases of construction. Notify Department personnel and the utility owner two weeks prior to commencement of any work and one week prior to service interruption. Keep utility owner's representatives informed of work progress and provide opportunity for inspection of construction and testing. The water lines on this project belong to the Harnett County Department of Public Utilities. The contact person for the owner is Mr. Shane Cummings (Senior Engineering Technician) and he can be reached by phone at (910) 893-7575 (extension 3275). Any work on the utility owner's lines must be coordinated through the Engineer and the utility owner before beginning.

Measurement and Payment

No direct payment will be made for utility construction work required by the preceding provisions, which are general requirements applying to utility construction, and all of the requirements stated will be considered incidental work, paid for at the contract unit prices of the various utility items included in the contract.

Associated fittings are considered incidental to the water line in accordance with the requirements of Section 1510 of the Standard Specifications.

GENERAL UTILITY REQUIREMENTS

Description

Construct various utilities as required by the contract or as directed. Apply the applicable provisions of the Rules and Regulations of the North Carolina Department of Environment and Natural Resources, Division of Environmental Health to the construction of water lines. Apply the Rules and Regulations of the North Carolina Department of Environment and Natural Resources, Division of Water Quality to the construction of sanitary sewer lines. Perform all work in accordance with the applicable plumbing codes.

Cooperation with the Utility Owner

The Utility owner owns the existing utility facilities and will own the new utility facilities after acceptance by the Department. The Department owns the construction contract and has administrative authority. Communications and decisions between the Contractor and Utility Owner are not binding upon the Department or this contract unless authorized by the Engineer. Agreements between the Utility Owner and Contractor for work that is not part of this contract or is secondary to this contract are allowed, but are not binding upon the Department. Provide access for Department personnel and the owner's representatives to all phases of construction. Notify Department personnel and the utility owner two weeks prior to commencement of any work and one week prior to service interruption. Keep utility owners' representatives informed of work progress and provide opportunity for inspection of construction and testing. Except in an emergency, do not operate any of the controls on the existing systems without prior approval of the owner. Notify the owner at least 48 hours in advance of all arrangements for temporary service and for agreement with the owner as to the time that service may be interrupted.

Utility Relocation and the Contractor's Responsibility

Make investigations for determining the exact location, size, and type material of the existing facilities as necessary for the construction of the proposed utilities and for avoiding damage to existing facilities. Repair any damage incurred to existing facilities to the original or better condition at no additional cost to the Department. Make final connections of the new work to the existing system where indicated on the plans, as required to fit the actual conditions, or as directed.

GENERAL UTILITY REQUIREMENTS (Continued)

Weekend, Night, and Holiday Work

Make connections between existing and proposed utilities at times most convenient to the public, without endangering the utility service, and in accordance with the utility owner's requirements. Make connections on weekends, at night, and on holidays if necessary.

Relation of Water Mains to Sewers

Lay water mains at least 10 feet laterally from existing or proposed sewers. If local conditions or barriers prevent a 10 foot separation, lay the water main with at least 18 inches vertical separation above the top of the sewer pipe either in a separate trench or in the same trench on a bench of undisturbed earth. When a proposed water main crosses over a proposed or existing sewer, lay the water main with at least 18 inches vertical separation above the top of the sewer. If local conditions or barriers prevent an 18 inch vertical separation, construct both the water main and the sewer for a distance of 10 feet on each side of the point crossing with ferrous pipe having water main quality joints. When a proposed water main crosses under a proposed or existing sewer, construct both the water main and the sewer of ferrous materials with joints that are equivalent to water main standards for a distance of 10 feet on each side of the point of crossing. Center the section of water pipe at the point of crossing.

Protection of Pedestrian and Vehicular Traffic

During the progress of the work, keep sidewalks and crossings open for the passage of pedestrians. Take necessary measures to keep roadways open for traffic unless lane or roadway closures are approved. Construct and maintain adequate and approved bridges over excavations as may be necessary for the purpose of accommodating pedestrians or vehicles. When open cut installation is allowed across a roadway and traffic is to be maintained, construct the installation in sections so that half the width of the roadway will be available to traffic. Provide all traffic control measures necessary to provide for safe traffic passage.

Submittals and Records

Deliver only approved materials to the project. Provide sufficient information as required under Sections 105 and 106 to demonstrate the materials meet the specifications and intended use. Provide 2 copies to the Utility Owner and 6 copies to the Engineer. Identify each item's intended use. As a minimum, the submitted information shall show the material description, brand name, stock number, size, rating, and manufacturing specification. Provide working drawings of thrust restraint designs and connection details along with schedules for performing the work. Provide As-Built plans of the installed utility. The plans shall include notations of the size and type material installed, coordinates of utility controls, and horizontal and vertical locations of the piping. Provide 2 copies to the Utility Owner and 2 copies to the Engineer.

Locating and Marking

Tape a continuous locator wire along the top of all piping. Mechanically fasten locator wire to valve boxes, meter boxes, fire hydrants, manhole covers and other above grade appurtenances. Install marking tape 18 to 24 inches below finished grade above all pipelines.

Placing Pipelines into Service

Make final connections to existing mains where indicated on the plans, as required to fit the actual conditions, or as directed. Provide sufficient work crews, equipment, and materials on site to assure quick and efficient connections. Schedule and notify owners and customers in advance of any interruptions of water service with ample time to make arrangements. Limit interruption of service to water customers to a maximum of 8 hours unless otherwise required or approved. Provide temporary connections as needed. Make final connections of the proposed sewer work to the existing system where indicated on the plans, as required to fit the actual conditions, or as directed. Notify the owner at least 24 hours in advance of all arrangements for temporary service and for agreement with the owner as to the time that service may be interrupted.

Measurement and Payment

The general utility construction work will be considered incidental and will be paid for at the contract unit prices of the various utility items included in the contract.

WATER LINE

All water line construction shall be done in accordance with Section 1510 of the Standard Specifications and all regulations as stipulated by the Utility Owner. Provide water lines suitable for use in transporting water. The Contractor shall verify that the pipe is appropriate for the test pressure of the system and the external loading. Use ductile iron fittings on water lines 4 inch or larger. Use #12 AWG solid-copper wire with blue insulation for the utility locator wires. Use 2 inch wide plastic marking tape colored blue with "Caution Water Line", or similar wording, permanently printed at 36 inch centers. Use Class B Concrete for reaction backing masonry. Protect steel rods and other metal clamps and lugs by galvanizing or painting with approved bituminous paint.

The water line shall be placed a minimum of three (3) feet under the existing stream bed.

Meet the installation standards of the AWWA or ASTM for water line construction. Apply all the requirements in Section 1505 for excavation, trenching, pipe laying, and backfill to water line installation. Install small diameter pipe (4" or less) under existing pavement by a trenchless method at no additional compensation. Connect the ends of the water service piping using AWWA C800 type couplings or fittings. Make NPT screw joints with a double wrap of Teflon tape and torque as required by the manufacturer. Store plastic pipe out of direct sunlight until placing. All plastic pipe showing discoloration or deterioration will be rejected for use and replaced with suitable pipe as specified under Article 106-9. Install water lines with 36 to 42 inches of cover to finished grade unless otherwise directed or approved. Install water lines with greater cover for short distances to accommodate utility controls, to make tie-ins to existing facilities, to eliminate high points in the pipeline, or to provide clearance from existing or proposed utilities, drainage, other obstacles or actual field conditions.

All testing and sterilization shall be done in accordance with Section 1510-3(A) of the Standard Specifications and conditions as specified by the utility owner.

The abandoned water line shall be filled with flowable grout (fill) according to the special provisions, details, or as directed by the Engineer included within this contract.

Installation of water line(s) at the environmentally sensitive area shall require Dewatering. See the Dewatering provision included within this contract proposal. The contractor shall take all necessary actions to ensure that the water line is relocated during any storm drain cross line installation process. Dewatering shall be paid for on a one time basis only per storm drain cross line installation.

Measurement and Payment

Water lines of the various sizes will be measured from end to end in place with no deduction for length through valves or other fixtures and paid for by the horizontal linear foot. + If the contract does not include such pay items, measurement will not be done and the items will be incidental to other contract pay items. Associated fittings are considered incidental to the water line in accordance with the requirements of Section 1510 of the Standard Specifications. Flowable grout (fill) shall be considered incidental to the placement of the water line. No direct payment will be made for any material, labor, or equipment utilized for filling the abandoned line.

Fittings are considered incidental to the water line in accordance with the requirements of Section 1510 of the Standard Specifications

Basis of payment:

2" Water Line, per linear foot (Contingent Item).

UTILITY CONTROLS (HYDRANTS/VALVES/METERS)

Provide appropriate control devices, valves, meters, back-flow preventors, and hydrants on water lines and force main sewers.

Apply all the requirements in Section 1505 for excavation, trenching, pipe laying, and backfill. Place two 4 inch by 8 inch by 16 inch concrete blocks beneath valves and fire hydrants for support. When necessary due to project staging, install valves, meters and fire hydrants as appropriate for the current grade and make adjustments to finished grade as work progresses. Provide enclosures with positive drainage for utility controls.

Valves

Install all valves with an approved valve box set flush with the ground or pavement. Place a 24 inch diameter precast concrete ring flush with the ground around all valve boxes not in pavement. Test and sterilize tapping valves prior to making the tap. Do not allow cuttings to enter the tapped main.

Meters

Install water meters adjacent to the right of way or as shown on the plans. Place meter boxes with the top of the meter box flush with finished grade of the project.

Fire Hydrants

Install fire hydrants outside of the vehicle recovery area of the roadway, adjacent to the right of way line, or in protected areas. Connect fire hydrants to the main with a 6 inch valve and branch line having at least as much cover as the distribution main. Set hydrants plumb with the pumper nozzle facing the roadway and with the breakaway safety flange between 1 and 4 inches above the finished surrounding grade. Except where approved otherwise, place hydrants into service as soon as practicable. Place at least 7 cubic feet of clean crushed stone around the base of the hydrant to insure drainage of the hydrant barrel. Where necessary, remove the hydrant shoe and replace with the appropriate type to connect a relocated hydrant to the new pipe. Furnish and install or remove hydrant extension pieces to provide the proper bury of the pipe and hydrant.

Line Stops

Provide line stop valves to temporarily shut down the flow in pressurized pipes. Provide line stops to temporarily dead end a pipeline when there are no available working valves on the existing piping. Provide line stops with bypass to isolate a section of the existing pipeline while maintaining the flow. After line stop valves are removed, permanently cap the tapping sleeve and backfill the entire excavation with compacted select material.

Miscellaneous Controls

Install corporation stops with tapping saddles for connecting 2 inch or smaller water lines to larger water lines. Install corporation stops at $45^{\circ} \pm 10^{\circ}$ from vertical on the larger line. To aid in testing and flushing, install corporation stops at all elevated points along the pipeline in order to bleed off all entrapped air.

Measurement and Payment

Valves, water meters, fire hydrants, line stops, and other items listed in the pay items will be measured and paid for per each for the appropriate size and type. Valves and other items on hydrant legs or service lines will not be measured or paid for.

The term *relocate* in a pay item means to physically move the existing item, either vertically or horizontally, using the appropriate materials to place the item into working order. Measurement and payment will be made per each for the appropriate size and type. No additional compensation will be made for adjustments due to project staging on new or relocated items.

Valve boxes, meter boxes, hot boxes, vaults, and manholes for protecting and servicing utility controls are considered incidental to the appropriate pay item.

A line stop with bypass consists of installing line stops on opposite ends of the piping to be isolated, tapping the piping beyond the line stops, and providing temporary bypass piping between the taps. The entire assembly of valves and piping will be measured as one unit and paid for per each.

Corporation stops or other items to aid in testing and flushing of the piping are incidental items.

UTILITY CONTROLS (Continued)

If the contract does not include such pay items, measurement will not be done and the items will be incidental to other contract pay items. All piping, fittings, controls, certifications, appurtenances, and other miscellaneous items necessary to place the new or relocated item in proper working condition are considered incidental.

The placement of cleaned crushed stone for the installation of control devices, valves, meters, back-flow preventors, and hydrants shall be considered incidental to installation of these items. There shall be no direct payment for the placement of the cleaned crushed stone.

Basis of payment:

Relocate Water Meter, per each (Contingent Item).

CONSTRUCTION BOX / RAIN GAGE

The contractor shall be responsible for the erection and maintenance of a Construction Box and Rain Gage for the life of the project or until the removal is deemed necessary by the Engineer. If the contractor elects to use the Multi-Sensor Precipitation Estimates (MPE) website (<http://www.nc-climate.ncsu.edu/dot/>), the rain gage will not be necessary. The purpose of the Construction box is so that all applicable environmental permits and erosion control plans are on site at all times and the purpose of the rain gage is to monitor rainfall amounts as required by erosion control regulations. There will be no direct payment for the Construction Box or the Rain Gage. **The placement and maintenance of the Construction Box and Rain Gage will be considered incidental to the project.** There shall be no direct payment for the installation and maintenance of the Construction Box or the Rain Gage.

STABILIZATION GUIDELINES

Stabilization for this project shall comply with the time frame guidelines as specified by the NCG-010000 general construction permit effective August 3, 2011 issued by the North Carolina Department of Environment and Natural Resources Division of Water Quality. Temporary or permanent ground cover stabilization shall occur within 7 calendar days from the last land disturbing activity, with the following exceptions in which temporary or permanent ground cover shall be provided in 14 calendar days from the last land-disturbing activity:

- Slopes between 2:1 and 3:1, with a slope length of 10 ft. or less
- Slopes 3:1 or flatter, with a slope of length of 50 ft. or less
- Slopes 4:1 or flatter

The stabilization timeframe for High Quality Water (HQW) Zones shall be 7 calendar days with no exceptions for slope grades or lengths. High Quality Water Zones (HQW) Zones are defined by North Carolina Administrative Code 15A NCAC 04A.0105 (25). Temporary and permanent ground cover stabilization shall be achieved in accordance with the provisions in this contract and as directed.

EROSION, SILTATION, AND POLLUTION CONTROL

The Contractor shall exercise every reasonable precaution and take all necessary measures throughout the life of the project to prevent erosion, siltation, and pollution in accordance with the applicable section of the Standard Specifications. Erosion control measures shall be installed and maintained in accordance with the plans for this project, Division 16 of the Standard Specifications, Section 1630 of the Standard Specifications, the NCDOT Best Management Practices for Construction and Maintenance Activities and in locations directed by the Engineer or his representative.

The NCDOT Best Management Practices for Construction and Maintenance Activities manual can be found on the Internet at the following web address:

http://ncdot.org/doh/operations/BMP_manual/default.html

Once the Engineer has determined that 80% coverage of permanent vegetation has been established, the Contractor will be notified to remove the remaining erosion control devices that are no longer needed. The Contractor will be responsible for, and shall correct any areas disturbed by operations performed in permanent vegetation establishment and the removal of temporary erosion control measures, whether occurring prior to or after placing traffic on the project.

No additional compensation will be made for maintenance and removal of temporary erosion control items. Final payment or retainage shall be held until such time as the Roadside Field Operations Unit releases the project from Erosion Control compliance review and all temporary erosion control items have been removed to the satisfaction of the Engineer.

Within seven (7) calendar days to fourteen (14) calendar days of completion of any phase of grading, all disturbed areas shall be planted or otherwise provided with temporary or permanent ground cover, devices, or structures sufficient to restrain erosion. The Erosion and Sediment Control plan will identify the areas that require seven (7) and/or fourteen (14) calendar day ground stabilization. The Contractor is herein advised to follow all current regulations set forth by the North Carolina Department of Environment and Natural Resources (NCDENR) Division of Water Quality (DWQ) as defined in the *General Stormwater Permit for Construction Activities NCG010000*.

The excavation of silt (maintenance) from erosion control devices shall be considered incidental to the maintenance of all applicable erosion control devices. There shall be no direct payment for silt excavation from erosion control devices.

PERMANENT VEGETATION ESTABLISHMENT

(2-16-12) (Rev. 10-15-13)

104

SP1 G16

Establish a permanent stand of the vegetation mixture shown in the contract. During the period between initial vegetation planting and final project acceptance, perform all work necessary to establish permanent vegetation on all erodible areas within the project limits, as well as, in borrow and waste pits. This work shall include erosion control device maintenance and installation, repair seeding and mulching, supplemental seeding and mulching, mowing, and fertilizer topdressing, as directed. All work shall be performed in accordance with the applicable section of the *2012 Standard Specifications*. All work required for initial vegetation planting shall be performed as a part of the work necessary for the completion and acceptance of the Intermediate Contract Time (ICT). Between the time of ICT and Final Project acceptance, or otherwise referred to as the vegetation establishment period, the Department will be responsible for preparing the required National Pollutant Discharge Elimination System (NPDES) inspection records.

Once the Engineer has determined that the permanent vegetation establishment requirement has been achieved at an 80% vegetation density (the amount of established vegetation per given area to stabilize the soil) and no erodible areas exist within the project limits, the Contractor will be notified to remove the remaining erosion control devices that are no longer needed. The Contractor will be responsible for, and shall correct any areas disturbed by operations performed in permanent vegetation establishment and the removal of temporary erosion control measures, whether occurring prior to or after placing traffic on the project.

Payment for *Response for Erosion Control, Seeding and Mulching, Repair Seeding, Supplemental Seeding, Mowing, Fertilizer Topdressing, Silt Excavation, and Stone for Erosion Control* will be made at contract unit prices for the affected items. Work required that is not represented by contract line items will be paid in accordance with Articles 104-7 or 104-3 of the *2012 Standard Specifications*. No additional compensation will be made for maintenance and removal of temporary erosion control items.

TEMPORARY SILT FENCE

Furnish material, construct, maintain, and remove temporary silt fence in locations shown on the plans or in locations that require surface drainage to be filtered. Install in locations as shown on the plans or as directed by the Engineer or his representative. Maintain the silt fence until the project is accepted or until the fence is removed. Remove and replace deteriorated or ineffective filter fabric. Remove and dispose of silt accumulations in accordance with Section 1630 when necessary or as directed. Leave silt fence in place until site stabilization and remove at project completion. Removed silt fence becomes the property of the Contractor. Dress and seed and mulch all areas where silt fence is removed in accordance with Section 1660.

The excavation of silt (maintenance) from erosion control devices shall be considered incidental to the maintenance of all applicable erosion control devices. There shall be no direct payment for silt excavation from erosion control devices.

Basis of payment:

Temporary Silt Fence, per linear foot.

TEMPORARY MULCHING SEED FOR TEMPORARY SEEDING FERTILIZER FOR TEMPORARY SEEDING

Temporary Mulching shall be done in accordance with Section 1615 of the Standard Specifications and/or as directed by the Engineer. Furnish, place, and secure mulch material to prevent excessive soil erosion during construction operations where it is impossible or impractical to perform permanent seeding and mulching. The actual conditions which occur during the construction of the project will determine the quantity of mulching. The quantity of mulching may be increased, decreased, or eliminated entirely as directed. Such variations in quantity will not be considered as alterations in the details of construction or a change in the character of work.

Temporary Mulching will be measured and paid in acres, measured along the surface of the ground over which temporary mulch has been placed as directed and accepted.

Seed and mulch selected areas in advance of the permanent seeding and mulching operations to minimize erosion of graded areas during construction operations. The work includes preparing seedbeds; furnishing, placing, and covering fertilizer and seed; furnishing and placing mulch; and other operations necessary for seeding the required areas. Perform temporary seeding promptly at the locations and under any of the following conditions when directed:

- (A)** When it is impossible or impractical to bring an area to the final line, grade, and finish so that permanent seeding and mulching operations can be performed without subsequent serious disturbance by additional grading;
- (B)** When erosion occurs or is considered to be potentially substantial on areas of graded roadbed where construction operations are temporarily suspended or where the grading of the roadbed has been completed substantially in advance of the paving construction;
- (C)** During seasons of the year when permanent seeding and mulching is prohibited by the contract;
- (D)** When an immediate cover would be desirable to minimize erosion, siltation, or pollution on any area.

The actual conditions that occur during the construction of the project will determine the quantity of seed or fertilizer to be used. The quantity of seed or fertilizer may be increased, decreased, or eliminated entirely as directed. Such variations in quantity will not be considered as alterations in the details of construction or a change in the character of the work.

Fertilizer shall be the same analysis as specified for *Seeding and Mulching* and applied at the rate of 400 pounds and seeded at the rate of 50 pounds per acre. Sweet Sudan Grass, German Millet or Browntop Millet shall be used in summer months and Rye Grain during the remainder of the year. The Engineer will determine the exact dates for using each kind of seed. The application of *Seed for Temporary Seeding* and *Fertilizer for Temporary Seeding* shall be done in accordance with Section 1620 of the Standard Specifications

There shall be no direct payment for damaged areas that require repair seeding. Repair, at no cost to the Department, any damage to earthwork or temporary seeding which is due to carelessness or neglect on the part of the Contractor.

Within seven (7) calendar days to fourteen (14) calendar days of completion of any phase of grading, all disturbed areas shall be planted or otherwise provided with temporary or permanent ground cover, devices, or structures sufficient to restrain erosion. The Erosion and Sediment Control plan will identify the areas that require seven (7) and/or fourteen (14) calendar day ground stabilization. The Contractor is herein advised to follow all current regulations set forth by the North Carolina Department of Environment and Natural Resources (NCDENR) Division of Water Quality (DWQ) as defined in the *General Stormwater Permit for Construction Activities NCG-010000*.

Basis of payment:

Temporary Mulching, per acre,
Seed for Temporary Seeding, per pound,
Fertilizer for Temporary Seeding, per ton.

SAFETY FENCE

Safety Fence shall consist of furnishing, installing and maintaining polyethylene or polypropylene fence along the outside riparian buffer, wetland, or water boundary located within the construction corridor to mark the areas that have been approved to infringe within the buffer, wetland or water. **The fence shall be installed prior to any land disturbing activities.** The contractor shall place Safety Fence at the limits of all environmentally permitted areas and as directed by the Engineer.

Polyethylene or polypropylene fence shall be a highly visible preconstructed safety fence approved by the Engineer. The fence material shall have an ultraviolet coating. Either wood posts or steel posts may be used. Wood posts shall be hardwood with a wedge or pencil tip at one end, and shall be at least 5 ft. in length with a minimum nominal 2" x 2" cross section. Steel posts shall be at least 5 ft. in length, and have a minimum weight of 0.85 lb./ft. of length.

No additional clearing and grubbing is anticipated for the installation of this fence; however, if any clearing and grubbing is required, it will be the minimum required for the installation of the safety fence. Such clearing shall include satisfactory removal and disposal of all trees, brush, stumps and other objectionable material.

The fence shall be erected to conform to the general contour of the ground. When determined necessary, minor grading along the fence line shall be performed to meet this requirement provided no obstructions to proper drainage are created. Posts shall be set and maintained in a vertical position and may be hand set or set with a post driver. If hand set, all backfill material shall be thoroughly tamped. Wood posts may be sharpened to a dull point if power driven. Posts damaged by power driving shall be removed and replaced prior to final acceptance. The tops of all wood posts shall be cut at a 30-degree angle. The wood posts may, at the option of the Contractor, be cut at this angle either before or after the posts are erected. The fence fabric shall be attached to the wood posts with one 2" galvanized wire staple across each cable or to the steel posts with wire or other acceptable means.

The Contractor shall be required to maintain the safety fence in a satisfactory condition for the duration of the project as determined by the Engineer.

Basis of payment:

Safety Fence, per linear feet.

ROLLED EROSION CONTROL PRODUCTS (EXCELSIOR MATTING FOR EROSION CONTROL)

Description

Furnish, place and maintain a rolled erosion control product (matting) on previously shaped and seeded drainage ditches, slopes or other areas at locations shown in the contract or as directed. Work includes providing all materials, excavation and backfilling, placing and securing matting and maintaining the drainage ditch. The conditions which occur during the construction of the project will determine the quantity of matting placed. The quantity of matting may be increased, decreased or eliminated entirely as directed. Such variations in quantity will not be considered as alterations in the details of construction or a change in the character of the work.

Materials

Refer to Division 10.

Item	Section
Matting for Erosion Control	1060-8
Staples	1060-8

Construction Methods

Place matting immediately following seeding. Provide a smooth soil surface free from stones, clods or debris that will prevent the contact of the matting with the soil. Preserve the required line, grade and cross section of the area covered. Unroll matting in the direction of the flow of water and apply without stretching so that it will lie smoothly but loosely on the soil surface. Bury the up-channel or top of slope end of each piece of matting in a narrow trench at least 6" deep and tamp firmly. Where one roll of matting ends and a second-roll begins, overlap the end of the upper roll over the buried end of the second roll so there is a 4" overlap. Construct staple checks 4" on center and every 30 ft longitudinally in the matting or as directed. Fold over and bury matting to the full depth of the trench, close and tamp firmly. Overlap matting at least 4" where 2 or more widths of matting are laid side by side. Place staples across matting at ends, junctions and check trenches approximately 10" apart. Place staples along the outer edges and down the center of each strip of matting 3 ft apart. Place staples along all lapped edges 10" apart. Install product with netting on the top side when excelsior or straw matting is used. The Engineer may require adjustments in the trenching or stapling requirements to fit individual cut or fill slope conditions.

Measurement and Payment

Matting will be measured and paid in square yards as measured along the surface of the ground, over which matting has been acceptably placed.

Basis of payment:

Eight foot (8') Excelsior Matting for Erosion Control, per square yard.

WATTLES WITH POLYACRYLAMIDE (PAM)

(10-19-10) (Rev. 1-17-12)

1060,1630,1631

T2

Description

Wattles are tubular products consisting of excelsior fibers encased in synthetic netting. Wattles are used on slopes or channels to intercept runoff and act as a velocity break. Wattles are to be placed at locations shown on the plans or as directed. Installation shall follow the detail provided in the plans and as directed. Work includes furnishing materials, installation of wattles, matting installation, PAM application, and removing wattles.

Materials

Wattle shall meet the following specifications:

100% Curled Wood(Excelsior) Fibers	
Minimum Diameter	12 in.
Minimum Density	2.5 lb/ft ³ +/- 10%
Net Material	Synthetic
Net Openings	1 in. x 1 in.
Net Configuration	Totally Encased
Minimum Weight	20 lb. +/- 10% per 10 ft. length

Anchors: Stakes shall be used as anchors.

Wooden Stakes:

Provide hardwood stakes a minimum of 2-ft. long with a 2 in. x 2 in. nominal square cross section. One end of the stake must be sharpened or beveled to facilitate driving down into the underlying soil.

Matting shall meet the requirements of section 1060-8 of the Standard Specifications, or shall meet specifications provided elsewhere in this contract.

Provide staples made of 0.125" diameter new steel wire formed into a *u* shape not less than 12" in length with a throat of 1" in width.

Polyacrylamide (PAM) shall be applied in powder form and shall be anionic or neutrally charged. Soil samples shall be obtained in areas where the wattles will be placed, and from offsite material used to construct the roadway, and analyzed for the appropriate PAM flocculant to be utilized with each wattle.

Construction Methods

Wattles shall be secured to the soil by wire staples approximately every 1 linear foot and at the end of each section of wattle. A minimum of 4 stakes shall be installed on the downstream side of the wattle with a maximum spacing of 2 linear feet along the wattle, and according to the detail. Install a minimum of 2 stakes on the upstream side of the wattle according to the detail provided in the plans. Stakes shall be driven into the ground a minimum of 10 in. with no more than 2 in. projecting from the top of the wattle. Drive stakes at an angle according to the detail provided in the plans.

Install wattles to the top of the ditch according to the detail provided in the plans. Overlap adjoining sections of wattles a minimum of 6 in.

Installation of matting shall be in accordance with the detail provided in the plans, and in accordance with section 1631-3(B) of the Standard Specifications, or in accordance with specifications provided elsewhere in this contract.

Apply PAM over the lower center portion of the wattle where the water is going to flow over at a rate of 3.5 ounces per wattle. PAM applications shall be done during construction activities after every rainfall event that is equal to or exceeds 0.50 in.

The Contractor shall maintain the wattles until the project is accepted or until the wattles are removed, and shall remove and dispose of silt accumulations at the wattles when so directed in accordance with the requirements of Section 1630 of the Standard Specifications.

Measurement and Payment

Wattles will be measured and paid for by the actual number of linear feet of wattles which are installed and accepted. Such price and payment will be full compensation for all work covered by this section, including, but not limited to, furnishing all materials, labor, equipment and incidentals necessary to install the *Wattles*.

Polyacrylamide(PAM) will be measured and paid for by the actual weight in pounds of PAM applied to the wattles. Such price and payment will be full compensation for all work covered by this section, including, but not limited to, furnishing all materials, labor, equipment and incidentals necessary to apply the *Polyacrylamide(PAM)*.

There shall be no direct payment for Matting, Staples or any other items necessary for the construction of the Wattles with Polyacrylamide. These items shall be considered incidental to the construction of the Wattles with Polyacrylamide.

The excavation of silt (maintenance) from erosion control devices shall be considered incidental to the maintenance of all applicable erosion control devices. There shall be no direct payment for silt excavation from erosion control devices.

Basis of payment:

Wattle, per linear foot,
Polyacrylamide (PAM), per pound.

SEEDING AND MULCHING (PERMANENT)

The Contractor shall seed all disturbed areas as directed by the Engineer, in accordance with Section 1660 of the Standard Specifications. Seeding and mulching shall immediately follow shoulder construction operations and in no case shall shoulder construction operations exceed seeding and mulching operations by more than two weeks without written permission of the Engineer. Failure to meet this requirement shall be cause to cease all operations until it can be met.

Seeding and Mulching: (East)

The kinds of seed and fertilizer, and the rates of application of seed, fertilizer, and limestone, shall be as stated below. During periods of overlapping dates, the kind of seed to be used shall be determined by the Engineer. All rates are in pounds per acre.

The kinds of seed and fertilizer, and the rates of application of seed, fertilizer, and limestone, shall be as stated below. During periods of overlapping dates, the kind of seed to be used shall be determined. All rates are in pounds per acre.

All Roadway Areas

March 1 - August 31

50# Tall Fescue
10# Centipede
25# Bermudagrass (hulled)
500# Fertilizer
4000# Limestone

September 1 - February 28

50# Tall Fescue
10# Centipede
35# Bermudagrass (unhulled)
500# Fertilizer
4000# Limestone

Waste and Borrow Locations

March 1 – August 31

75# Tall Fescue
25# Bermudagrass (hulled)
500# Fertilizer
4000# Limestone

September 1 - February 28

75# Tall Fescue
35# Bermudagrass (unhulled)
500# Fertilizer
4000# Limestone

Note: 50# of Bahiagrass may be substituted for either Centipede or Bermudagrass only upon Engineer's request.

Approved Tall Fescue Cultivars

2 nd	Duster	Magellan	Rendition
Millennium	Endeavor	Masterpiece	Scorpion
Avenger	Escalade	Matador	Shelby
Barlexas	Falcon II, III, IV & V	Matador GT	Signia
Barlexas II	Fidelity	Millennium	Silverstar
Barrera	Finesse II	Montauk	Southern Choice II
Barrington	Firebird	Mustang 3	Stetson
Biltmore	Focus	Olympic Gold	Tarheel
Bingo	Grande II	Padre	Titan Ltd
Bravo	Greenkeeper	Paraiso	Titanium
Cayenne	Greystone	Picasso	Tomahawk
Chapel Hill	Inferno	Piedmont	Tacer
Chesapeake	Justice	Pure Gold	Trooper
Constitution	Jaguar 3	Prospect	Turbo
Chipper	Kalahari	Quest	Ultimate
Coronado	Kentucky 31	Rebel Exeda	Watchdog
Coyote	Kitty Hawk	Rebel Sentry	Wolfpack
Davinci	Kitty Hawk 2000	Regiment II	
Dynasty	Lexington	Rembrandt	
Dominion			

On cut and fill slopes 2:1 or steeper Centipede shall be applied at the rate of 5 pounds per acre and add 20# of Sericea Lespedeza from January 1 - December 31.

Fertilizer shall be 10-20-20 analysis. A different analysis of fertilizer may be used provided the 1-2-2 ratio is maintained and the rate of application adjusted to provide the same amount of plant food as a 10-20-20 analysis and as directed.

All areas seeded and mulched shall be tacked with asphalt. Crimping of straw in lieu of asphalt tack shall not be allowed on this project.

CRIMPING STRAW MULCH

Crimping shall be required on this project adjacent to any section of roadway where traffic is to be maintained or allowed during construction. In areas within six feet of the edge of pavement, straw is to be applied and then crimped. After the crimping operation is complete, an additional application of straw shall be applied and immediately tacked with a sufficient amount of undiluted emulsified asphalt.

Straw mulch shall be of sufficient length and quality to withstand the crimping operation.

Crimping equipment including power source shall be subject to the approval of the Engineer providing that maximum spacing of crimper blades shall not exceed 8".

Within seven (7) calendar days to fourteen (14) calendar days of completion of any phase of grading, all disturbed areas shall be planted or otherwise provided with temporary or permanent ground cover, devices, or structures sufficient to restrain erosion. The Erosion and Sediment Control plan will identify the areas that require seven (7) and/or fourteen (14) calendar day ground stabilization. The Contractor is herein advised to follow all current regulations set forth by the North Carolina Department of Environment and Natural Resources (NCDENR) Division of Water Quality (DWQ) as defined in the *General Stormwater Permit for Construction Activities NCG-010000*.

Basis of payment:
Seeding and Mulching, per acre.

TEMPORARY ROCK SILT CHECK TYPE A WITH EXCELSIOR MATTING AND POLYACRYLAMIDE (PAM)

Description

Temporary Rock Silt Checks Type A with Excelsior Matting and Polyacrylamide (PAM) are devices utilized in temporary and permanent ditches to reduce runoff velocity and incorporate PAM into the construction runoff to increase settling of sediment particles and reduce turbidity of runoff. Temporary Rock Silt Checks Type A with Excelsior Matting and PAM are to be placed at locations shown on the plans or as directed. Installation shall follow the detail provided in the plans and as directed. Work includes furnishing materials, installation of Temporary Rock Silt Checks Type A, matting installation, PAM application, and removing Temporary Rock Silt Checks Type A with Excelsior Matting and PAM.

Materials

Structural stone shall be class B stone that meets the requirements of Section 1042 of the Standard Specifications for Stone for Erosion Control, Class B. Sediment control stone shall be #5 or #57 stone, which meets the requirements of Section 1005 of the Standard Specifications for these stone sizes. Matting shall meet the requirements of Excelsior Matting in section 1060-8(B) of the Standard Specifications, or shall meet specifications provided elsewhere in this contract. Polyacrylamide (PAM) shall be applied in powder form and shall be anionic or neutrally charged. Soil samples shall be obtained in areas where the Temporary Rock Silt Checks Type A with Excelsior Matting and PAM will be placed, and from offsite material used to construct the roadway, and analyzed for the appropriate PAM flocculant to be utilized with each Temporary Rock Silt Check Type A. The PAM product used shall be listed on the North Carolina Department of Environment and Natural Resources (NCDENR) Division of Water Quality (DWQ) web site as an approved PAM product for use in North Carolina.

Construction Methods

Temporary Rock Silt Checks Type A shall be installed in accordance with Section 1633- 3(A) of the Standard Specifications, Roadway Standard Drawing No. 1633.01 and the detail provided in the plans. Installation of matting shall be in accordance with the detail provided in the plans, and anchored by placing Class B stone on top of the matting at the upper and lower ends. Apply PAM at a rate of 3.5 ounces over the center portion of the Temporary Rock Silt Checks Type A and matting where the water is going to flow over. PAM applications shall be done during construction activities and after every rainfall event that is equal to or exceeds 0.50 in. The Contractor shall maintain the Temporary Rock Silt Checks Type A with Excelsior Matting and PAM until the project is accepted or until the Temporary Rock Silt Checks Type A with Excelsior Matting and PAM are removed, and shall remove and dispose of silt accumulations at the Temporary Rock Silt Checks Type A with Excelsior Matting and PAM when so directed in accordance with the requirements of Section 1630 of the Standard Specifications.

Measurement and Payment

Temporary Rock Silt Checks Type A will be measured and paid for in accordance with section 1633-5 of the Standard Specifications, or in accordance with specifications provided elsewhere in this contract. Matting will be measured and paid for in accordance with section 1631-4 of the Standard Specifications, or in accordance with specifications provided elsewhere in this contract.

Polyacrylamide(PAM) will be measured and paid for by the actual weight in pounds of PAM applied to the Temporary Rock Silt Checks Type A. Such price and payment will be full compensation for all work covered by this section, including, but not limited to, furnishing all materials, labor, equipment and incidentals necessary to apply the *Polyacrylamide(PAM)*.

There shall be no direct payment for Matting, Staples or any other items necessary for the construction of the Temporary Rock Silt Checks Type A with Excelsior Matting. These items shall be considered incidental to the construction of the Temporary Rock Silt Checks Type A with Excelsior Matting. The excavation of silt (maintenance) from erosion control devices shall be considered incidental to the maintenance of all applicable erosion control devices. There shall be no direct payment for silt excavation from erosion control devices.

Basis of payment:

Temporary Rock Silt Check, Type A, with Excelsior Matting, per each, (Contingent Item),
Polyacrylamide (PAM), per pound.

TEMPORARY ROCK SILT CHECKS

Construct, maintain, and remove devices placed in ditches, diversions or swales to reduce water velocity and contain sediment in accordance with Division 16 and Section 1633 of the NCDOT Standard Specifications for Roads and Structures. The actual conditions which occur during the construction of the project will determine the quantity of temporary rock silt checks constructed. The quantity of silt check dams may be increased, decreased, or eliminated entirely as directed. Such variations in quantity not be considered as alterations in the details of construction or a change in the character of the work.

Type A

Place structural stone in the channel, ditch, diversion or swale with approximately 2:1 side slopes. Place sediment control stone, approximately 12 inches thick on the upstream side.

Type B

Construct temporary rock silt check type-B devices as shown on the plans and at other locations as directed.

Maintain the temporary rock silt checks, and remove and dispose of silt accumulations at the silt checks when so directed in accordance with Section 1630. Remove temporary rock silt checks as the project nears completion. The actual time of removal will be as directed. After removal of silt checks, dress the area to blend with existing contours and seed and mulch the area in accordance with Section 1660.

The excavation of silt (maintenance) from erosion control devices shall be considered incidental to the maintenance of all applicable erosion control devices. There shall be no direct payment for silt excavation from erosion control devices.

Basis of payment:

Temporary Rock Silt Check, Type A, per each (Contingent Item),
Temporary Rock Silt Check, Type B, per each (Contingent Item).

SPECIAL SEDIMENT CONTROL FENCE

Furnish materials, construct, maintain and remove special sediment control fence. Place special sediment control fence as shown in the plans or as directed.

Materials

Refer to Division 10.

Item	Section
Sediment Control Stone, Standard Size No. 5 or 57	1005

(A) Posts

Provide steel posts in accordance with Subarticle 1605-2(A).

(B) 1/4" Hardware Cloth

Provide hardware cloth with 1/4" openings constructed from 24 gauge wire.

(C) Attachment Device

Provide No. 9 staple with at least 1 1/2" length or other approved attachment device.

Construction Methods

Install hardware cloth and sediment control stone in accordance with *Roadway Standard Drawings* No. 1606.01. Attach hardware cloth to post with wire staple or other acceptable methods. Maintain the special sediment control fence until the project is accepted or until the fence is removed. Remove and dispose of silt accumulations at the fence when so directed in accordance with Section 1630.

There shall be no direct payment for Posts, Hardware Cloth, Staples or any other items necessary for the construction of the Special Sediment Control Fence. These items shall be considered incidental to the construction of the Special Sediment Control Fence.

The excavation of silt (maintenance) from erosion control devices shall be considered incidental to the maintenance of all applicable erosion control devices. There shall be no direct payment for silt excavation from erosion control devices.

Basis of payment:

Special Sediment Control Fence, per linear foot.

DEWATERING

All environmentally permitted sites shall require dewatering. The Division Six preferred method for dewatering will be bypass pumping (see detail included within this contract proposal). Materials used in impervious dikes include but are not limited to steel sheet piles, Aqua Barriers, etc. This will include all material, labor and equipment needed to satisfy the OSHA safety standards and also to satisfy the guidelines of the attached environmental permits. A copy of the environmental permits shall be onsite during construction activities. Any violation of the permits could result in fines. The Contractor's work shall be halted if the turbidity reaches in excess of 50 NTU's. The Contractor shall not resume work until corrections are made.

Included in this contract is a typical section for bypass pumping. The guidelines to be used for this activity can be found in the Best Management Practices for Construction and Maintenance Activities which are available as a down load on our web site. The link can be found on the internet at the following web address:

http://www.ncdot.org/doh/operations/BMP_manual/.

Dewatering shall be paid for at a one time basis per environmentally permitted site.

Basis of payment:

Dewatering, per each.

RIPRAP

Description

Place riprap at the locations designated in the contract, plans or as directed by the Engineer. All work shall done in accordance with the Section 876 of the Standard Specifications and the current NCDOT Roadway Standard Drawings 876.01, 876.02, 876.03, and 876.04 or as directed by the Engineer.

Materials

Refer to Division 10

Item	Section
Plain Riprap	1042
Geotextile for Drainage, Type 2	1056

Plain riprap consists of quarry run stone, or field stone, or broken concrete, and is classified by size into either Class 1 or Class 2. Plain riprap when classified as either Class A or Class B shall consist of quarry run stone or field stone. Use the class and thickness called for on the plans. Place geotextile fabric under plain riprap where indicated in the plans.

Plain Riprap

Place the stone where indicated in the plans, unless otherwise directed. Grade the stone so that the smaller stones are uniformly distributed throughout the mass. Place the stone by mechanical methods, augmented by hand placing where necessary. Complete the riprap to form a properly graded, dense, neat layer of stone. Install the riprap to at least the thickness indicated on the plans. At locations where riprap is required for channel changes and drainage ditches, place the riprap prior to diverting the water into the channel changes and drainage ditches. At locations where riprap is required at the outlets of pipe culverts, place the riprap immediately after completion of the pipe culvert installation. Unless otherwise directed, grade the surfaces that receive geotextile fabric to the lines and grades shown on the plans. Provide a surface free of obstructions, debris, and soft pockets. Do not leave fabric uncovered for more than 7 days. Lay the fabric smooth and free from tension, stress, folds, wrinkles, or creases. Make horizontal overlaps a minimum of 12 inches with the upper fabric overlapping the lower fabric. Make vertical overlaps a minimum of 18 inches with the upstream fabric overlapping the downstream fabric. Place the riprap in a continuous manner. Protect the fabric from damage while placing riprap or other materials. In the event that the fabric is displaced or damaged during riprap placement, remove the riprap and reposition or replace the fabric prior to replacement of the riprap, all at no additional cost to the Department.

Measurement and Payment

Riprap, Class B will be measured and paid for in tons that have been incorporated into the completed and accepted work. The riprap will be measured by being weighed in trucks on certified platform scales or other certified weighing devices.

Geotextile for Drainage will be measured and paid for in square yards measured along the surface of the ground, over fabric that has been acceptably placed. No separate measurement will be made for overlapping fabric, sewing seams or bonding. Such price will include, but is not limited to all excavation, embankment preparation, and backfilling; and stone or broken concrete riprap, geotextile fabric, and other materials.

Basis of payment:

Riprap, Class B, per ton (Contingent Item),

Geotextile for Drainage, Type 2, per square yard (Contingent Item).

PERMITS

(10-18-95) (Rev. 2-18-14)

Z-1

The Contractor's attention is directed to the following permits, which have been issued to the Department of Transportation by the authority granting the permit.

<u>PERMIT</u>	<u>AUTHORITY GRANTING THE PERMIT</u>
Dredge and Fill and/or Work in Navigable Waters (404)	U. S. Army Corps of Engineers
Water Quality (401)	Division of Environmental Management, DENR State of North Carolina
Buffer Certification	Division of Environmental Management, DENR State of North Carolina
State Dredge and Fill and/or CAMA	Division of Coastal Management, DENR State of North Carolina
Navigation	U. S. Coast Guard
Trout Buffer Zone Waiver	Department of Energy, Mineral, and Land Resources, DENR, State of North Carolina
CCPCUA	Division of Water Resources, DENR State of North Carolina
TVA	Tennessee Valley Authority
FERC	Federal Energy Regulatory Commission

The Contractor shall comply with all applicable permit conditions during construction of this project. Those conditions marked by * are the responsibility of the Department and the Contractor has no responsibility in accomplishing those conditions.

Agents of the permitting authority will periodically inspect the project for adherence to the permits.

The Contractor's attention is also directed to Articles 107-10 and 107-13 of the *2012 Standard Specifications* and the following:

Should the Contractor propose to utilize construction methods (such as temporary structures or fill in waters and/or wetlands for haul roads, work platforms, cofferdams, etc.) not specifically identified in the permit (individual, general, or nationwide) authorizing the project it shall be the Contractor's responsibility to coordinate with the Engineer to determine what, if any, additional permit action is required. The Contractor shall also be responsible for initiating the request for the authorization of such construction method by the permitting agency. The request shall be submitted through the Engineer. The Contractor shall not utilize the construction method until it is approved by the permitting agency. The request normally takes approximately 60 days to process; however, no extensions of time or additional compensation will be granted for delays resulting from the Contractor's request for approval of construction methods not specifically identified in the permit.

Where construction moratoriums are contained in a permit condition which restricts the Contractor's activities to certain times of the year, those moratoriums will apply only to the portions of the work taking place in the waters or wetlands provided that activities outside those areas is done in such a manner as to not affect the waters or wetlands.

EROSION AND SEDIMENT CONTROL/STORMWATER CERTIFICATION

(1-16-07) (Rev 9-18-12)

105-16, 225-2, 16

SP1 G180

General

Schedule and conduct construction activities in a manner that will minimize soil erosion and the resulting sedimentation and turbidity of surface waters. Comply with the requirements herein regardless of whether or not a National Pollution discharge Elimination System (NPDES) permit for the work is required.

Establish a chain of responsibility for operations and subcontractors' operations to ensure that the *Erosion and Sediment Control/Stormwater Pollution Prevention Plan* is implemented and maintained over the life of the contract.

- (A) *Certified Supervisor* - Provide a certified Erosion and Sediment Control/Stormwater Supervisor to manage the Contractor and subcontractor operations, insure compliance with Federal, State and Local ordinances and regulations, and manage the Quality Control Program.
- (B) *Certified Foreman* - Provide a certified, trained foreman for each construction operation that increases the potential for soil erosion or the possible sedimentation and turbidity of surface waters.
- (C) *Certified Installer* - Provide a certified installer to install or direct the installation for erosion or sediment/stormwater control practices.
- (D) *Certified Designer* - Provide a certified designer for the design of the erosion and sediment control/stormwater component of reclamation plans and, if applicable, for the design of the project erosion and sediment control/stormwater plan.

Roles and Responsibilities

- (A) *Certified Erosion and Sediment Control/Stormwater Supervisor* - The Certified Supervisor shall be Level II and responsible for ensuring the erosion and sediment control/stormwater plan is adequately implemented and maintained on the project and for conducting the quality control program. The Certified Supervisor shall be on the project within 24 hours notice from initial exposure of an erodible surface to the project's final acceptance. Perform the following duties:
 - (1) *Manage Operations* - Coordinate and schedule the work of subcontractors so that erosion and sediment control/stormwater measures are fully executed for each operation and in a timely manner over the duration of the contract.
 - (a) Oversee the work of subcontractors so that appropriate erosion and sediment control/stormwater preventive measures are conformed to at each stage of the work.
 - (b) Prepare the required National Pollutant Discharge Elimination System (NPDES) Inspection Record and submit to the Engineer.
 - (c) Attend all weekly or monthly construction meetings to discuss the findings of the NPDES inspection and other related issues.
 - (d) Implement the erosion and sediment control/stormwater site plans requested.
 - (e) Provide any needed erosion and sediment control/stormwater practices for the Contractor's temporary work not shown on the plans, such as, but not limited to work platforms, temporary construction, pumping operations, plant and storage yards, and cofferdams.
 - (f) Acquire applicable permits and comply with requirements for borrow pits, dewatering, and any temporary work conducted by the Contractor in jurisdictional areas.
 - (g) Conduct all erosion and sediment control/stormwater work in a timely and workmanlike manner.
 - (h) Fully perform and install erosion and sediment control/stormwater work prior to any suspension of the work.

- (i) Coordinate with Department, Federal, State and Local Regulatory agencies on resolution of erosion and sediment control/stormwater issues due to the Contractor's operations.
 - (j) Ensure that proper cleanup occurs from vehicle tracking on paved surfaces or any location where sediment leaves the Right-of-Way.
 - (k) Have available a set of erosion and sediment control/stormwater plans that are initialed and include the installation date of Best Management Practices. These practices shall include temporary and permanent groundcover and be properly updated to reflect necessary plan and field changes for use and review by Department personnel as well as regulatory agencies.
- (2) Requirements set forth under the NPDES Permit - The Department's NPDES Stormwater permit (NCS000250) outlines certain objectives and management measures pertaining to construction activities. The permit references *NCG010000, General Permit to Discharge Stormwater* under the NPDES, and states that the Department shall incorporate the applicable requirements into its delegated Erosion and Sediment Control Program for construction activities disturbing one or more acres of land. The Department further incorporates these requirements on all contracted bridge and culvert work at jurisdictional waters, regardless of size. Some of the requirements are, but are not limited to:
- (a) Control project site waste to prevent contamination of surface or ground waters of the state, i.e. from equipment operation/maintenance, construction materials, concrete washout, chemicals, litter, fuels, lubricants, coolants, hydraulic fluids, any other petroleum products, and sanitary waste.
 - (b) Inspect erosion and sediment control/stormwater devices and stormwater discharge outfalls at least once every 7 calendar days, twice weekly for construction related *Federal Clean Water Act, Section 303(d)* impaired streams with turbidity violations, and within 24 hours after a significant rainfall event of 0.5 inch that occurs within a 24 hour period.
 - (c) Maintain an onsite rain gauge or use the Department's Multi-Sensor Precipitation Estimate website to maintain a daily record of rainfall amounts and dates.
 - (d) Maintain erosion and sediment control/stormwater inspection records for review by Department and Regulatory personnel upon request.
 - (e) Implement approved reclamation plans on all borrow pits, waste sites and staging areas.
 - (f) Maintain a log of turbidity test results as outlined in the Department's Procedure for Monitoring Borrow Pit Discharge.
 - (g) Provide secondary containment for bulk storage of liquid materials.
 - (h) Provide training for employees concerning general erosion and sediment control/stormwater awareness, the Department's NPDES Stormwater Permit NCS000250 requirements, and the applicable requirements of the *General Permit, NCG010000*.
 - (i) Report violations of the NPDES permit to the Engineer immediately who will notify the Division of Water Quality Regional Office within 24 hours of becoming aware of the violation.
- (3) Quality Control Program - Maintain a quality control program to control erosion, prevent sedimentation and follow provisions/conditions of permits. The quality control program shall:
- (a) Follow permit requirements related to the Contractor and subcontractors' construction activities.
 - (b) Ensure that all operators and subcontractors on site have the proper erosion and sediment control/stormwater certification.
 - (c) Notify the Engineer when the required certified erosion and sediment control/stormwater personnel are not available on the job site when needed.
 - (d) Conduct the inspections required by the NPDES permit.

- (e) Take corrective actions in the proper timeframe as required by the NPDES permit for problem areas identified during the NPDES inspections.
- (f) Incorporate erosion control into the work in a timely manner and stabilize disturbed areas with mulch/seed or vegetative cover on a section-by-section basis.
- (g) Use flocculants approved by state regulatory authorities where appropriate and where required for turbidity and sedimentation reduction.
- (h) Ensure proper installation and maintenance of temporary erosion and sediment control devices.
- (i) Remove temporary erosion or sediment control devices when they are no longer necessary as agreed upon by the Engineer.
- (j) The Contractor's quality control and inspection procedures shall be subject to review by the Engineer. Maintain NPDES inspection records and make records available at all times for verification by the Engineer.

(B) *Certified Foreman* - At least one Certified Foreman shall be onsite for each type of work listed herein during the respective construction activities to control erosion, prevent sedimentation and follow permit provisions:

- (1) Foreman in charge of grading activities
- (2) Foreman in charge of bridge or culvert construction over jurisdictional areas
- (3) Foreman in charge of utility activities

The Contractor may request to use the same person as the Level II Supervisor and Level II Foreman. This person shall be onsite whenever construction activities as described above are taking place. This request shall be approved by the Engineer prior to work beginning.

The Contractor may request to name a single Level II Foreman to oversee multiple construction activities on small bridge or culvert replacement projects. This request shall be approved by the Engineer prior to work beginning.

(C) *Certified Installers* - Provide at least one onsite, Level I Certified Installer for each of the following erosion and sediment control/stormwater crew:

- (1) Seeding and Mulching
- (2) Temporary Seeding
- (3) Temporary Mulching
- (4) Sodding
- (5) Silt fence or other perimeter erosion/sediment control device installations
- (6) Erosion control blanket installation
- (7) Hydraulic tackifier installation
- (8) Turbidity curtain installation
- (9) Rock ditch check/sediment dam installation
- (10) Ditch liner/matting installation
- (11) Inlet protection
- (12) Riprap placement
- (13) Stormwater BMP installations (such as but not limited to level spreaders, retention/detention devices)
- (14) Pipe installations within jurisdictional areas

If a Level I *Certified Installer* is not onsite, the Contractor may substitute a Level II Foreman for a Level I Installer, provided the Level II Foreman is not tasked to another crew requiring Level II Foreman oversight.

(D) *Certified Designer* - Include the certification number of the Level III-B Certified Designer on the erosion and sediment control/stormwater component of all reclamation plans and if applicable, the certification number of the Level III-A Certified Designer on the design of the project erosion and sediment control/stormwater plan.

Preconstruction Meeting

Furnish the names of the *Certified Erosion and Sediment Control/Stormwater Supervisor, Certified Foremen, Certified Installers* and *Certified Designer* and notify the Engineer of changes in certified personnel over the life of the contract within 2 days of change.

Ethical Responsibility

Any company performing work for the North Carolina Department of Transportation has the ethical responsibility to fully disclose any reprimand or dismissal of an employee resulting from improper testing or falsification of records.

Revocation or Suspension of Certification

Upon recommendation of the Chief Engineer to the certification entity, certification for *Supervisor, Certified Foremen, Certified Installers* and *Certified Designer* may be revoked or suspended with the issuance of an *Immediate Corrective Action (ICA), Notice of Violation (NOV)*, or *Cease and Desist Order* for erosion and sediment control/stormwater related issues.

The Chief Engineer may recommend suspension or permanent revocation of certification due to the following:

- (A) Failure to adequately perform the duties as defined within this certification provision.
- (B) Issuance of an ICA, NOV, or Cease and Desist Order.
- (C) Failure to fully perform environmental commitments as detailed within the permit conditions and specifications.
- (D) Demonstration of erroneous documentation or reporting techniques.
- (E) Cheating or copying another candidate's work on an examination.
- (F) Intentional falsification of records.
- (G) Directing a subordinate under direct or indirect supervision to perform any of the above actions.
- (H) Dismissal from a company for any of the above reasons.
- (I) Suspension or revocation of one's certification by another entity.

Suspension or revocation of a certification will be sent by certified mail to the certificant and the Corporate Head of the company that employs the certificant.

A certificant has the right to appeal any adverse action which results in suspension or permanent revocation of certification by responding, in writing, to the Chief Engineer within 10 calendar days after receiving notice of the proposed adverse action.

Chief Engineer
1536 Mail Service Center
Raleigh, NC 27699-1536

Failure to appeal within 10 calendar days will result in the proposed adverse action becoming effective on the date specified on the certified notice. Failure to appeal within the time specified will result in a waiver of all future appeal rights regarding the adverse action taken. The certificant will not be allowed to perform duties associated with the certification during the appeal process.

The Chief Engineer will hear the appeal and make a decision within 7 days of hearing the appeal. Decision of the Chief Engineer will be final and will be made in writing to the certificant.

If a certification is temporarily suspended, the certificant shall pass any applicable written examination and any proficiency examination, at the conclusion of the specified suspension period, prior to having the certification reinstated.

Measurement and Payment

Certified Erosion and Sediment Control/Stormwater Supervisor, Certified Foremen, Certified Installers and *Certified Designer* will be incidental to the project for which no direct compensation will be made.

Guidance on Complying with the Applicable Requirements of NCG01

In a memorandum dated July 14, 2008, the North Carolina Division of Water Quality (NCDWQ) informed the North Carolina Department of Transportation (NCDOT) of the requirements applicable to their activities covered under the NCG0 1 general permit. The purpose of this document is to provide guidance on complying with the applicable requirements of the NCG0 1. This document will provide definitions of terms, specific details on monitoring and recordkeeping, and recommendations to maintain compliance with the NCG0 1. This guidance is applicable only to the current NCG01 general permit. Should revisions be made to the NCG01 general permit when it is renewed, a new guidance document will be issued reflecting those revisions.

Definitions

303(d) listed stream – Streams listed on the 303(d) impaired waters list are required to be inspected twice a week. This requirement applies only to streams listed for pollutants associated with construction activities such as turbidity, sediment, or biological integrity and included on DWQ's Construction 3 03(d) list. Unnamed tributaries draining to the impaired stream reach are assumed to carry the 303(d) listing as well.

Idle projects – Idle projects are projects that have not been completed but where no construction activity occurs for 21 calendar days or more and have been adequately stabilized with temporary vegetation pursuant to Division of Land Resources guidelines. Typically, these projects are two- part projects (grading and paving) with significant gaps between activities or where the project has been stabilized with temporary ground cover and construction has been halted due to weather, funding, or other constraints.

Pollutants for visual inspection

Clarity – Clarity refers to the clarity of the stormwater discharge and can range from clear to opaque or very cloudy.

Floating Solids – Floating solids are any solids, foams, or debris observed floating on the surface of the stormwater discharge.

Suspended Solids – Suspended solids is the type of pollution most often associated with construction activities. This term refers to suspended sediment or other particles in the discharge. This also includes sediment that was once suspended and has been deposited outside the limits of the work site.

Oil Sheen – Oil sheen refers to the shiny or colored luster that result from petrochemicals in the discharge.

Other Obvious Indicators of Stormwater Pollution – This could be anything not listed above such as de-icing material, slag, industrial pollutants, etc.

Stormwater Discharge Outfall (SDO) – A SDO is defined as a point of stormwater discharge to waters of the State (streams, wetlands, open water). An outfall is not restricted to pipes and includes any type of conveyance or any discharge from a BMP that discharges to waters of the State.

Monitoring and Recordkeeping

All SDOs shall be inspected once every seven calendar days [twice every seven calendar days for 303(d) listed streams (see definition above)] or within 24 hours after a 0.5" rainfall per 24 hour period. It is recommended that outfalls or discharges from BMPs not discharging to waters of the State be monitored and maintained regularly. This is highly recommended for discharges located adjacent to sensitive areas such as adjacent landowners or those that are in close proximity to waters of the State.

SDOs on idle projects (See definition above) may be inspected less frequently. The inspection frequency shall not be less than once every 14 calendar days (once every seven calendar days for 3 03(d) listed streams). However, SDOs on inactive projects must be inspected within 24 hours after a 0.5" rainfall per 24 hour period.

Inspections of SDOs shall include observing the discharge from the outfall if there is discharge present and making a qualitative assessment of the discharge for clarity, floating solids, suspended solids, oil sheen, and other obvious indicators of stormwater pollution. Qualitative assessment of the discharge includes visually observing the outfall at a point just prior to discharging to waters of the State for the parameters listed above. The qualitative assessment shall be made before the discharge joins or is diluted by any other waste stream, body of water, or substance. Samples of the discharge at the SDO are not required.

Results of the inspections shall be recorded for each SDO. NCDWQ has provided a recommended method on its website for qualitatively assessing the discharge using a numerical scale. However, NCDOT may develop and submit to NCDWQ for approval, its own method for qualitatively assessing the discharge. The method should clearly describe the range of values, should be comparable to NCDWQ's recommended method, and should be used consistently in all of the NCDOT Division Offices.

If visible sedimentation is leaving NCDOT property, regardless of whether it is from a SDO or not, corrective actions shall be taken to control the discharge of sediments outside of NCDOT's property. Events where sediment leaves the NCDOT property limits shall be documented in the records along with the corrective actions taken and when the situation was resolved. Any event where sediment leaves the NCDOT property limits or where pollutants are discharged to waters of the State shall be reported to the appropriate offices of NCDWQ and NCDLR within 24 hours of first knowledge of the occurrence. NCDWQ shall be consulted regarding appropriate clean-up techniques for any loss of pollutants to waters of the State or protected buffer areas.

Rainfall shall be monitored and recorded everyday. A rain gage shall be maintained on each construction site. It is recommended that at least one rain gage per 3 miles of roadway be maintained on each site unless topographical conditions (e.g., mountains) necessitate more gages. The State Climate Office of North Carolina Multi-sensor Precipitation Estimate (MPE) or other approved remote sensing precipitation tools may be substituted for rain gages and used to monitor daily rainfall and to trigger inspections due to a 0.5" or greater rainfall event.

At a minimum, inspection records shall include the following:

- Daily rainfall amounts (record zero if no rain fell), identification of each discharge outfall inspected, date and time of the inspection, name and signature of the person performing the inspection, indication of characteristics of the stormwater discharge (clarity, floating solids, suspended solids, oil sheen, etc.), description of other indicators of stormwater pollution, indication of visible sediment leaving the NCDOT property limits or entering waters of the State, actions taken to correct/prevent sedimentation outside the NCDOT property limits or in waters of the State, and when the action was completed.
- For visible sedimentation found outside the NCDOT property limits, inspection records must include an explanation as to the actions taken to control future releases, actions taken to clean up the sediment that has left the NCDOT property limits, and when the action was completed.

The contractor shall be responsible for maintaining the NPDES Stormwater Inspections form (SPPPF0RM30). This form can be downloaded from:

<https://apps.dot.state.nc.us/quickfind/forms/Default.aspx>

Inspection(s) shall be made in the presence of NCDOT personnel, and signed off by the contractor's representative and the NCDOT representative once the inspection process has been performed.

AWARD OF CONTRACT

SR 2309 (LEANNA LANE)

The basis for award of this contract will be determined by multiplying the unit bid prices by the quantities given and comparing the total amount bid for the following items:

- Mobilization
- Clearing and Grubbing
- Undercut Excavation
- Comprehensive Grading
- Borrow Material
- 15" RC Pipe Culvert, Class III
- 18" RC Pipe Culvert, Class III
- 24" RC Pipe Culvert, Class III
- Pipe Removal
- Aggregate Base Course
- Incidental Stone
- ACSC Type SF 9.5 A
- Asphalt Binder, PG 64-22
- Temporary Silt Fence
- Temporary Mulching
- Seed for Temporary Seeding
- Fertilizer for Temporary Seeding
- Safety Fence
- Matting for Erosion Control (8' Excelsior)
- Temporary Excelsior Wattle
- Polyacrylamide (PAM)
- Seeding and Mulching (Permanent)
- Special Sediment Control Fence
- Dewatering

All other items are listed for contingent bids. The Contractor may be required to furnish and install these items if it is determined by the Engineer to be necessary. **NOTE: Bids are required on all contingent items. Any proposals which do not have a bid for contingent items will be considered non-responsive and will not be considered for award of contract.**

The quantities listed are for bidding purposes only. The actual quantities will be determined by the Engineer.

"The North Carolina Department of Transportation, in accordance with the provisions of *Title VI of the Civil Rights Act of 1964* (78 Stat. 252) and the Regulations of the Department of Transportation (49 C.F.R., Part 21), issued pursuant to such act, hereby notifies all bidders that it will affirmatively insure that the contract entered into pursuant to this advertisement will be awarded to the lowest responsible bidder without discrimination on the ground of race, color, or national origin".

DIVISION CONTRACT

Standard Special Provisions

NCDOT GENERAL SEED SPECIFICATION FOR SEED QUALITY

(5-17-11)

Z-3

Seed shall be sampled and tested by the North Carolina Department of Agriculture and Consumer Services, Seed Testing Laboratory. When said samples are collected, the vendor shall supply an independent laboratory report for each lot to be tested. Results from seed so sampled shall be final. Seed not meeting the specifications shall be rejected by the Department of Transportation and shall not be delivered to North Carolina Department of Transportation warehouses. If seed has been delivered it shall be available for pickup and replacement at the supplier's expense.

Any re-labeling required by the North Carolina Department of Agriculture and Consumer Services, Seed Testing Laboratory, that would cause the label to reflect as otherwise specified herein shall be rejected by the North Carolina Department of Transportation.

Seed shall be free from seeds of the noxious weeds Johnsongrass, Balloonvine, Jimsonweed, Witchweed, Itchgrass, Serrated Tussock, Showy Crotalaria, Smooth Crotalaria, Sicklepod, Sandbur, Wild Onion, and Wild Garlic. Seed shall not be labeled with the above weed species on the seed analysis label. Tolerances as applied by the Association of Official Seed Analysts will NOT be allowed for the above noxious weeds except for Wild Onion and Wild Garlic.

Tolerances established by the Association of Official Seed Analysts will generally be recognized. However, for the purpose of figuring pure live seed, the found pure seed and found germination percentages as reported by the North Carolina Department of Agriculture and Consumer Services, Seed Testing Laboratory will be used. Allowances, as established by the NCDOT, will be recognized for minimum pure live seed as listed on the following pages.

The specifications for restricted noxious weed seed refers to the number per pound as follows:

<u>Restricted Noxious Weed</u>	<u>Limitations per Lb. Of Seed</u>	<u>Restricted Noxious Weed</u>	<u>Limitations per Lb. of Seed</u>
Blessed Thistle	4 seeds	Cornflower (Ragged Robin)	27 seeds
Cocklebur	4 seeds	Texas Panicum	27 seeds
Spurred Anoda	4 seeds	Bracted Plantain	54 seeds
Velvetleaf	4 seeds	Buckhorn Plantain	54 seeds
Morning-glory	8 seeds	Broadleaf Dock	54 seeds
Corn Cockle	10 seeds	Curly Dock	54 seeds
Wild Radish	12 seeds	Dodder	54 seeds
Purple Nutsedge	27 seeds	Giant Foxtail	54 seeds
Yellow Nutsedge	27 seeds	Horsenettle	54 seeds
Canada Thistle	27 seeds	Quackgrass	54 seeds
Field Bindweed	27 seeds	Wild Mustard	54 seeds
Hedge Bindweed	27 seeds		

Seed of Pensacola Bahiagrass shall not contain more than 7% inert matter, Kentucky Bluegrass, Centipede and Fine or Hard Fescue shall not contain more than 5% inert matter whereas a maximum of 2% inert matter will be allowed on all other kinds of seed. In addition, all seed shall not contain more than 2% other crop seed nor more than 1% total weed seed. The germination rate as tested by the North Carolina Department of Agriculture shall not fall below 70%, which includes both dormant and hard seed. Seed shall be labeled with not more than 7%, 5% or 2% inert matter (according to above specifications), 2% other crop seed and 1% total weed seed.

Exceptions may be made for minimum pure live seed allowances when cases of seed variety shortages are verified. Pure live seed percentages will be applied in a verified shortage situation. Those purchase orders of deficient seed lots will be credited with the percentage that the seed is deficient.

FURTHER SPECIFICATIONS FOR EACH SEED GROUP ARE GIVEN BELOW:

Minimum 85% pure live seed; maximum 1% total weed seed; maximum 2% total other crop seed; maximum 144 restricted noxious weed seed per pound. Seed less than 83% pure live seed will not be approved.

Sericea Lespedeza
Oats (seeds)

Minimum 80% pure live seed; maximum 1% total weed seed; maximum 2% total other crop; maximum 144 restricted noxious weed seed per pound. Seed less than 78% pure live seed will not be approved.

Tall Fescue (all approved varieties)	Bermudagrass
Kobe Lespedeza	Browntop Millet
Korean Lespedeza	German Millet – Strain R
Weeping Lovegrass	Clover – Red/White/Crimson
Carpetgrass	

Minimum 78% pure live seed; maximum 1% total weed seed; maximum 2% total other crop seed; maximum 144 restricted noxious weed seed per pound. Seed less than 76% pure live seed will not be approved.

Common or Sweet Sundangrass

Minimum 76% pure live seed; maximum 1% total weed seed; maximum 2% total other crop seed; maximum 144 restricted noxious weed seed per pound. Seed less than 74% pure live seed will not be approved.

Rye (grain; all varieties)
Kentucky Bluegrass (all approved varieties)
Hard Fescue (all approved varieties)
Shrub (bicolor) Lespedeza

Minimum 70% pure live seed; maximum 1% total weed seed; maximum 2% total other crop seed; maximum 144 noxious weed seed per pound. Seed less than 70% pure live seed will not be approved.

Centipedegrass	Japanese Millet
Crownvetch	Reed Canary Grass
Pensacola Bahiagrass	Zoysia
Creeping Red Fescue	

Minimum 70% pure live seed; maximum 1% total weed seed; maximum 2% total other crop seed; maximum 5% inert matter; maximum 144 restricted noxious weed seed per pound.

Barnyard Grass
Sweet Clover
Big Bluestem
Little Bluestem
Bristly Locust
Birdsfoot Trefoil
Indiangrass
Orchardgrass
Switchgrass
Yellow Blossom Sweet Clover

ERRATA

(1-17-12) (Rev. 04-21-15)

Z-4

Revise the *2012 Standard Specifications* as follows:

Division 2

Page 2-7, line 31, Article 215-2 Construction Methods, replace “Article 107-26” with “Article 107-25”.

Page 2-17, Article 226-3, Measurement and Payment, line 2, delete “pipe culverts.”

Page 2-20, Subarticle 230-4(B), Contractor Furnished Sources, change references as follows: **Line 1**, replace “(4) Buffer Zone” with “(c) Buffer Zone”; **Line 12**, replace “(5) Evaluation for Potential Wetlands and Endangered Species” with “(d) Evaluation for Potential Wetlands and Endangered Species”; and **Line 33**, replace “(6) Approval” with “(4) Approval”.

Division 3

Page 3-1, after line 15, Article 300-2 Materials, replace “1032-9(F)” with “1032-6(F)”.

Division 4

Page 4-77, line 27, Subarticle 452-3(C) Concrete Coping, replace “sheet pile” with “reinforcement”.

Division 6

Page 6-7, line 31, Article 609-3 Field Verification of Mixture and Job Mix Formula Adjustments, replace “30” with “45”.

Page 6-10, line 42, Subarticle 609-6(C)(2), replace “Subarticle 609-6(E)” with “Subarticle 609-6(D)”.

Page 6-11, Table 609-1 Control Limits, replace “Max. Spec. Limit” for the Target Source of $P_{0.075}/P_{be}$ Ratio with “1.0”.

Page 6-40, Article 650-2 Materials, replace “Subarticle 1012-1(F)” with “Subarticle 1012-1(E)”

Division 7

Page 7-1, Article 700-3, CONCRETE HAULING EQUIPMENT, line 33, replace “competition” with “completion”.

Division 8

Page 8-23, line 10, Article 838-2 Materials, replace “Portland Cement Concrete, Class B” with “Portland Cement Concrete, Class A”.

Division 10

Page 10-166, Article 1081-3 Hot Bitumen, replace “Table 1081-16” with “Table 1081-2”, replace “Table 1081-17” with “Table 1081-3”, and replace “Table 1081-18” with “Table 1081-4”.

Division 12

Page 12-7, Table 1205-3, add “FOR THERMOPLASTIC” to the end of the title.

Page 12-8, Subarticle 1205-5(B), line 13, replace “Table 1205-2” with “Table 1205-4”.

Page 12-8, Table 1205-4 and 1205-5, replace “THERMOPLASTIC” in the title of these tables with “POLYUREA”.

Page 12-9, Subarticle 1205-6(B), line 21, replace “Table 1205-4” with “Table 1205-6”.

Page 12-11, Subarticle 1205-8(C), line 25, replace “Table 1205-5” with “Table 1205-7”.

Division 15

Page 15-4, Subarticle 1505-3(F) Backfilling, line 26, replace “Subarticle 235-4(C)” with “Subarticle 235-3(C)”.

Page 15-6, Subarticle 1510-3(B), after line 21, replace the allowable leakage formula with the following: $W = LD\sqrt{P} \div 148,000$

Page 15-6, Subarticle 1510-3(B), line 32, delete “may be performed concurrently or” and replace with “shall be performed”.

Page 15-17, Subarticle 1540-3(E), line 27, delete “Type 1”.

Division 17

Page 17-26, line 42, Subarticle 1731-3(D) Termination and Splicing within Interconnect Center, delete this subarticle.

Revise the *2012 Roadway Standard Drawings* as follows:

1633.01 Sheet 1 of 1, English Standard Drawing for Matting Installation, replace “1633.01” with “1631.01”.

PLANT AND PEST QUARANTINES

(Imported Fire Ant, Gypsy Moth, Witchweed, And Other Noxious Weeds)

(3-18-03) (Rev. 10-15-13)

Z-04a

Within Quarantined Area

This project may be within a county regulated for plant and/or pests. If the project or any part of the Contractor's operations is located within a quarantined area, thoroughly clean all equipment prior to moving out of the quarantined area. Comply with federal/state regulations by obtaining a certificate or limited permit for any regulated article moving from the quarantined area.

Originating in a Quarantined County

Obtain a certificate or limited permit issued by the N.C. Department of Agriculture/United States Department of Agriculture. Have the certificate or limited permit accompany the article when it arrives at the project site.

Contact

Contact the N.C. Department of Agriculture/United States Department of Agriculture at 1-800-206-9333, 919-733-6932, or <http://www.ncagr.gov/plantind/> to determine those specific project sites located in the quarantined area or for any regulated article used on this project originating in a quarantined county.

Regulated Articles Include

1. Soil, sand, gravel, compost, peat, humus, muck, and decomposed manure, separately or with other articles. This includes movement of articles listed above that may be associated with cut/waste, ditch pulling, and shoulder cutting.
2. Plants with roots including grass sod.
3. Plant crowns and roots.
4. Bulbs, corms, rhizomes, and tubers of ornamental plants.
5. Hay, straw, fodder, and plant litter of any kind.
6. Clearing and grubbing debris.
7. Used agricultural cultivating and harvesting equipment.
8. Used earth-moving equipment.
9. Any other products, articles, or means of conveyance, of any character, if determined by an inspector to present a hazard of spreading imported fire ant, gypsy moth, witchweed or other noxious weeds.

MINIMUM WAGES

(7-21-09)

Z-5

FEDERAL: The Fair Labor Standards Act provides that with certain exceptions every employer shall pay wages at the rate of not less than SEVEN DOLLARS AND TWENTY FIVE CENTS (\$7.25) per hour.

STATE: The North Carolina Minimum Wage Act provides that every employer shall pay to each of his employees, wages at a rate of not less than SEVEN DOLLARS AND TWENTY FIVE CENTS (\$7.25) per hour.

The minimum wage paid to all skilled labor employed on this contract shall be SEVEN DOLLARS AND TWENTY FIVE CENTS (\$7.25) per hour.

The minimum wage paid to all intermediate labor employed on this contract shall be SEVEN DOLLARS AND TWENTY FIVE CENTS (\$7.25) per hour.

The minimum wage paid to all unskilled labor on this contract shall be SEVEN DOLLARS AND TWENTY FIVE CENTS (\$7.25) per hour.

This determination of the intent of the application of this act to the contract on this project is the responsibility of the Contractor.

The Contractor shall have no claim against the Department of Transportation for any changes in the minimum wage laws, Federal or State. It is the responsibility of the Contractor to keep fully informed of all Federal and State Laws affecting his contract.

MINORITY BUSINESS ENTERPRISE AND WOMEN BUSINESS ENTERPRISE (DIVISIONS)

(10-16-07)(Rev. 12-17-13)

102-15(J)

SP1 G67

Description

The purpose of this Special Provision is to carry out the North Carolina Department of Transportation's policy of ensuring nondiscrimination in the award and administration of contracts financed in whole or in part with State funds.

Definitions

Additional MBE/WBE Subcontractors - Any MBE/WBE submitted at the time of bid that will not be used to meet either the MBE or WBE goal. No submittal of a Letter of Intent is required.

Committed MBE/WBE Subcontractor - Any MBE/WBE submitted at the time of bid that is being used to meet either the MBE or WBE goal by submission of a Letter of Intent. Or any MBE or WBE used as a replacement for a previously committed MBE or WBE firm.

Contract Goals Requirement - The approved MBE and WBE participation at time of award, but not greater than the advertised contract goals for each.

Goal Confirmation Letter - Written documentation from the Department to the bidder confirming the Contractor's approved, committed MBE and WBE participation along with a listing of the committed MBE and WBE firms.

Manufacturer - A firm that operates or maintains a factory or establishment that produces on the premises, the materials or supplies obtained by the Contractor.

MBE Goal - A portion of the total contract, expressed as a percentage, that is to be performed by committed MBE subcontractor(s).

Minority Business Enterprise (MBE) - A firm certified as a Disadvantaged Minority-Owned Business Enterprise through the North Carolina Unified Certification Program.

Regular Dealer - A firm that owns, operates, or maintains a store, warehouse, or other establishment in which the materials or supplies required for the performance of the contract are bought, kept in stock, and regularly sold to the public in the usual course of business. A regular dealer engages in, as its principal business and in its own name, the purchase and sale or lease of the products in question. A regular dealer in such bulk items as steel, cement, gravel, stone, and petroleum products need not keep such products in stock, if it owns and operates distribution equipment for the products. Brokers and packagers are not regarded as manufacturers or regular dealers within the meaning of this section.

North Carolina Unified Certification Program (NCUCP) - A program that provides comprehensive services and information to applicants for MBE/WBE certification. The MBE/WBE program follows the same regulations as the federal Disadvantaged Business Enterprise (DBE) program in accordance with 49 CFR Part 26.

United States Department of Transportation (USDOT) - Federal agency responsible for issuing regulations (49 CFR Part 26) and official guidance for the DBE program.

WBE Goal - A portion of the total contract, expressed as a percentage, that is to be performed by committed WBE subcontractor(s).

Women Business Enterprise (WBE) - A firm certified as a Disadvantaged Women-Owned Business Enterprise through the North Carolina Unified Certification Program.

Forms and Websites Referenced in this Provision

Payment Tracking System - On-line system in which the Contractor enters the payments made to MBE and WBE subcontractors who have performed work on the project.
<https://apps.dot.state.nc.us/Vendor/PaymentTracking/>

DBE-IS Subcontractor Payment Information - Form for reporting the payments made to all MBE/WBE firms working on the project. This form is for paper bid projects only.
<http://www.ncdot.org/doh/forms/files/DBE-IS.xls>

RF-1 MBE/WBE Replacement Request Form - Form for replacing a committed MBE or WBE.

<http://connect.ncdot.gov/projects/construction/Construction%20Forms/DBE%20MBE%20WBE%20Replacement%20Request%20Form.pdf>

SAF Subcontract Approval Form - Form required for approval to sublet the contract.

<http://connect.ncdot.gov/projects/construction/Construction%20Forms/Subcontract%20Approval%20Form%20Rev.%202012.zip>

JC-1 Joint Check Notification Form - Form and procedures for joint check notification. The form acts as a written joint check agreement among the parties providing full and prompt disclosure of the expected use of joint checks.

<http://connect.ncdot.gov/projects/construction/Construction%20Forms/Joint%20Check%20Notification%20Form.pdf>

Letter of Intent - Form signed by the Contractor and the MBE/WBE subcontractor, manufacturer or regular dealer that affirms that a portion of said contract is going to be performed by the signed MBE/WBE for the amount listed at the time of bid.

<http://connect.ncdot.gov/letting/LetCentral/Letter%20of%20Intent%20to%20Perform%20as%20a%20Subcontractor.pdf>

Listing of MBE and WBE Subcontractors Form - Form for entering MBE/WBE subcontractors on a project that will meet this MBE and WBE goals. This form is for paper bids only.

[http://connect.ncdot.gov/municipalities/Bid%20Proposals%20for%20LGA%20Content/09%20MBE-WBE%20Subcontractors%20\(State\).doc](http://connect.ncdot.gov/municipalities/Bid%20Proposals%20for%20LGA%20Content/09%20MBE-WBE%20Subcontractors%20(State).doc)

Subcontractor Quote Comparison Sheet - Spreadsheet for showing all subcontractor quotes in the work areas where MBEs and WBEs quoted on the project. This sheet is submitted with good faith effort packages.

<http://connect.ncdot.gov/business/SmallBusiness/Documents/DBE%20Subcontractor%20Quote%20Comparison%20Example.xls>

MBE and WBE Goal

The following goals for participation by Minority Business Enterprises and Women Business Enterprises are established for this contract:

(A) Minority Business Enterprises **[3]** %

- (1) *If the MBE goal is more than zero*, the Contractor shall exercise all necessary and reasonable steps to ensure that MBEs participate in at least the percent of the contract as set forth above as the MBE goal.
- (2) *If the MBE goal is zero*, the Contractor shall make an effort to recruit and use MBEs during the performance of the contract. Any MBE participation obtained shall be reported to the Department.

(B) Women Business Enterprises **[2]** %

- (1) *If the WBE goal is more than zero*, the Contractor shall exercise all necessary and reasonable steps to ensure that WBEs participate in at least the percent of the contract as set forth above as the WBE goal.
- (2) *If the WBE goal is zero*, the Contractor shall make an effort to recruit and use WBEs during the performance of the contract. Any WBE participation obtained shall be reported to the Department.

Directory of Transportation Firms (Directory)

Real-time information is available about firms doing business with the Department and firms that are certified through NCUCP in the Directory of Transportation Firms. Only firms identified in the Directory as MBE and WBE certified shall be used to meet the MBE and WBE goals respectively. The Directory can be found at the following link.

<https://partner.ncdot.gov/VendorDirectory/default.html>

The listing of an individual firm in the directory shall not be construed as an endorsement of the firm's capability to perform certain work.

Listing of MBE/WBE Subcontractors

At the time of bid, bidders shall submit all MBE and WBE participation that they anticipate to use during the life of the contract. Only those identified to meet the MBE goal and the WBE goal will be considered committed, even though the listing shall include both committed MBE/WBE subcontractors and additional MBE/WBE subcontractors. Any additional MBE/WBE subcontractor participation submitted at the time of bid will be used toward overall race-neutral goals. Only those firms with current MBE and WBE certification at the time of bid opening will be acceptable for listing in the bidder's submittal of MBE and WBE participation. The Contractor shall indicate the following required information:

- (A) *If either the MBE or WBE goal is more than zero*,
 - (1) Bidders, at the time the bid proposal is submitted, shall submit a listing of MBE/WBE participation, including the names and addresses on *Listing of MBE and WBE Subcontractors* contained elsewhere in the contract documents in order for the bid to be considered responsive. Bidders shall indicate the total dollar value of the MBE and WBE participation for the contract.
 - (2) If bidders have no MBE or WBE participation, they shall indicate this on the *Listing of MBE and WBE Subcontractors* by entering the word "None" or the number "0." This form shall be completed in its entirety. **Blank forms will not be deemed to represent zero participation.** Bids submitted that do not have MBE and WBE participation indicated on the appropriate form will not be read publicly during the opening of bids. The Department will not consider these bids for award and the proposal will be rejected.
 - (3) The bidder shall be responsible for ensuring that the MBE/WBE is certified at the time of bid by checking the Directory of Transportation Firms. If the firm is not certified at the time of the bid-letting, that MBE's or WBE's participation will not count towards achieving the corresponding goal.
- (B) *If either the MBE or WBE goal is zero*, entries on the *Listing of MBE and WBE Subcontractors* are not required for the zero goal, however any MBE or WBE participation that is achieved during the project shall be reported in accordance with requirements contained elsewhere in the special provision.

MBE or WBE Prime Contractor

When a certified MBE or WBE firm bids on a contract that contains MBE and WBE goals, the firm is responsible for meeting the goals or making good faith efforts to meet the goals, just like any other bidder. In most cases, a MBE or WBE bidder on a contract will meet one of the goals by virtue of the work it performs on the contract with its own forces. However, all the work that is performed by the MBE or WBE bidder and any other similarly certified subcontractors will count toward the goal. The MBE or WBE bidder shall list itself along with any MBE or WBE subcontractors, if any, in order to receive credit toward the goals.

For example, on a proposed contract, the WBE goal is 10%, and the MBE goal is 8%. A WBE bidder puts in a bid where they will perform 40% of the contract work and have a WBE subcontractor which will perform another 5% of the work. Together the two WBE firms submit on the *Listing of MBE and WBE Subcontractors* a value of 45% of the contract which fulfills the WBE goal. The 8% MBE goal shall be obtained through MBE participation with MBE certified subcontractors or documented through a good faith effort. It should be noted that you cannot combine the two goals to meet an overall value. The two goals shall remain separate.

MBE/WBE prime contractors shall also follow Sections A or B listed under *Listing of MBE/WBE Subcontractors* just as a non-MBE/WBE bidder would.

Written Documentation – Letter of Intent

The bidder shall submit written documentation for each MBE/WBE that will be used to meet the MBE and WBE goals of the contract, indicating the bidder's commitment to use the MBE/WBE in the contract. This documentation shall be submitted on the Department's form titled *Letter of Intent*.

The documentation shall be received in the office of the Engineer no later than 12:00 noon of the sixth calendar day following opening of bids, unless the sixth day falls on Saturday, Sunday or an official state holiday. In that situation, it is due in the office of the Engineer no later than 12:00 noon on the next official state business day.

If the bidder fails to submit the Letter of Intent from each committed MBE and WBE to be used toward the MBE and WBE goals, or if the form is incomplete (i.e. both signatures are not present), the MBE/WBE participation will not count toward meeting the MBE/WBE goal. If the lack of this participation drops the commitment below either the MBE or WBE goal, the Contractor shall submit evidence of good faith efforts for the goal not met, completed in its entirety, to the Engineer no later than 12:00 noon of the eighth calendar day following opening of bids, unless the eighth day falls on Saturday, Sunday or an official state holiday. In that situation, it is due in the office of the Engineer no later than 12:00 noon on the next official state business day.

Submission of Good Faith Effort

If the bidder fails to meet or exceed either the MBE or the WBE goal, the apparent lowest responsive bidder shall submit to the Department documentation of adequate good faith efforts made to reach that specific goal(s).

One complete set and (No. of Copies) copies of this information shall be received in the office of the Engineer no later than 12:00 noon of the sixth calendar day following opening of bids, unless the sixth day falls on Saturday, Sunday or an official state holiday. In that situation, it is due in the office of the Engineer no later than 12:00 noon on the next official state business day.

Note: Where the information submitted includes repetitious solicitation letters, it will be acceptable to submit a representative letter along with a distribution list of the firms that were solicited. Documentation of MBE/WBE quotations shall be a part of the good faith effort submittal. This documentation may include written subcontractor quotations, telephone log notations of verbal quotations, or other types of quotation documentation.

Consideration of Good Faith Effort for Projects with MBE/WBE Goals More Than Zero

Adequate good faith efforts mean that the bidder took all necessary and reasonable steps to achieve the goal which, by their scope, intensity, and appropriateness, could reasonably be expected to obtain sufficient MBE/WBE participation. Adequate good faith efforts also mean that the bidder actively and aggressively sought MBE/WBE participation. Mere *pro forma* efforts are not considered good faith efforts.

The Department will consider the quality, quantity, and intensity of the different kinds of efforts a bidder has made. Listed below are examples of the types of actions a bidder will take in making a good faith effort to meet the goals and are not intended to be exclusive or exhaustive, nor is it intended to be a mandatory checklist.

- (A) Soliciting through all reasonable and available means (e.g. attendance at pre-bid meetings, advertising, written notices, use of verifiable electronic means through the use of the NCDOT Directory of Transportation Firms) the interest of all certified MBEs/WBEs who have the capability to perform the work of the contract. The bidder must solicit this interest within at least 10 days prior to bid opening to allow the MBEs/WBEs to respond to the solicitation. Solicitation shall provide the opportunity to MBEs/WBEs within the Division and surrounding Divisions where the project is located. The bidder must determine with certainty if the MBEs/WBEs are interested by taking appropriate steps to follow up initial solicitations.
- (B) Selecting portions of the work to be performed by MBEs/WBEs in order to increase the likelihood that the MBE and WBE goals will be achieved.
 - (1) Where appropriate, break out contract work items into economically feasible units to facilitate MBE/WBE participation, even when the prime contractor might otherwise prefer to perform these work items with its own forces.
 - (2) Negotiate with subcontractors to assume part of the responsibility to meet the contract MBE/WBE goals when the work to be sublet includes potential for MBE/WBE participation (2nd and 3rd tier subcontractors).
- (C) Providing interested MBEs/WBEs with adequate information about the plans, specifications, and requirements of the contract in a timely manner to assist them in responding to a solicitation.
- (D) (1) Negotiating in good faith with interested MBEs/WBEs. It is the bidder's responsibility to make a portion of the work available to MBE/WBE subcontractors and suppliers and to select those portions of the work or material needs consistent with the available MBE/WBE subcontractors and suppliers, so as to facilitate MBE/WBE participation. Evidence of such negotiation includes the names, addresses, and telephone numbers of MBEs/WBEs that were considered; a description of the information provided regarding the plans and specifications for the work selected for subcontracting; and evidence as to why additional agreements could not be reached for MBEs/WBEs to perform the work.
 - (2) A bidder using good business judgment would consider a number of factors in negotiating with subcontractors, including MBE/WBE subcontractors, and would take a firm's price and capabilities as well as contract goals into consideration. However, the fact that there may be some additional costs involved in finding and using MBEs/WBEs is not in itself sufficient reason for a bidder's failure to meet the contract MBE or WBE goals, as long as such costs are reasonable. Also, the ability or desire of a prime contractor to perform the work of a contract with its own organization does not relieve the bidder of the responsibility to make good faith efforts. Bidding contractors are not, however, required to accept higher quotes from MBEs/WBEs if the price difference is excessive or unreasonable.

- (E) Not rejecting MBEs/WBEs as being unqualified without sound reasons based on a thorough investigation of their capabilities. The bidder's standing within its industry, membership in specific groups, organizations, or associates and political or social affiliations (for example, union vs. non-union employee status) are not legitimate causes for the rejection or non-solicitation of bids in the bidder's efforts to meet the project goal.
- (F) Making efforts to assist interested MBEs/WBEs in obtaining bonding, lines of credit, or insurance as required by the recipient or bidder.
- (G) Making efforts to assist interested MBEs/WBEs in obtaining necessary equipment, supplies, materials, or related assistance or services.
- (H) Effectively using the services of available minority/women community organizations; minority/women contractors' groups; Federal, State, and local minority/women business assistance offices; and other organizations as allowed on a case-by-case basis to provide assistance in the recruitment and placement of MBEs/WBEs. Contact within 7 days from the bid opening NCDOT's Business Development Manager in the Business Opportunity and Work Force Development Unit to give notification of the bidder's inability to get MBE or WBE quotes.
- (I) Any other evidence that the bidder submits which shows that the bidder has made reasonable good faith efforts to meet the MBE and WBE goal.

In addition, the Department may take into account the following:

- (1) Whether the bidder's documentation reflects a clear and realistic plan for achieving the MBE and WBE goals.
- (2) The bidders' past performance in meeting the MBE and WBE goals.
- (3) The performance of other bidders in meeting the MBE and WBE goals. For example, when the apparent successful bidder fails to meet the goals, but others meet it, you may reasonably raise the question of whether, with additional reasonable efforts the apparent successful bidder could have met the goals. If the apparent successful bidder fails to meet the MBE and WBE goals, but meets or exceeds the average MBE and WBE participation obtained by other bidders, the Department may view this, in conjunction with other factors, as evidence of the apparent successful bidder having made a good faith effort.

If the Department does not award the contract to the apparent lowest responsive bidder, the Department reserves the right to award the contract to the next lowest responsive bidder that can satisfy to the Department that the MBE and WBE goals can be met or that an adequate good faith effort has been made to meet the MBE and WBE goals.

Non-Good Faith Appeal

The Engineer will notify the contractor verbally and in writing of non-good faith. A contractor may appeal a determination of non-good faith made by the Goal Compliance Committee. If a contractor wishes to appeal the determination made by the Committee, they shall provide written notification to the Engineer. The appeal shall be made within 2 business days of notification of the determination of non-good faith.

Counting MBE/WBE Participation Toward Meeting MBE/WBE Goals

(A) Participation

The total dollar value of the participation by a committed MBE/WBE will be counted toward the contract goal requirements. The total dollar value of participation by a committed MBE/WBE will be based upon the value of work actually performed by the MBE/WBE and the actual payments to MBE/WBE firms by the Contractor.

(B) Joint Checks

Prior notification of joint check use shall be required when counting MBE/WBE participation for services or purchases that involves the use of a joint check. Notification shall be through submission of Form JC-1 (*Joint Check Notification Form*) and the use of joint checks shall be in accordance with the Department's Joint Check Procedures.

(C) Subcontracts (Non-Trucking)

A MBE/WBE may enter into subcontracts. Work that a MBE subcontracts to another MBE firm may be counted toward the MBE contract goal requirement. The same holds for work that a WBE subcontracts to another WBE firm. Work that a MBE subcontracts to a non-MBE firm does not count toward the MBE contract goal requirement. Again, the same holds true for the work that a WBE subcontracts to a non-WBE firm. If a MBE or WBE contractor or subcontractor subcontracts a significantly greater portion of the work of the contract than would be expected on the basis of standard industry practices, it shall be presumed that the MBE or WBE is not performing a commercially useful function. The MBE/WBE may present evidence to rebut this presumption to the Department. The Department's decision on the rebuttal of this presumption may be subject to review by the Office of Inspector General, NCDOT.

(D) Joint Venture

When a MBE or WBE performs as a participant in a joint venture, the Contractor may count toward its contract goal requirement a portion of the total value of participation with the MBE or WBE in the joint venture, that portion of the total dollar value being a distinct clearly defined portion of work that the MBE or WBE performs with its forces.

(E) Suppliers

A contractor may count toward its MBE or WBE requirement 60 percent of its expenditures for materials and supplies required to complete the contract and obtained from a MBE or WBE regular dealer and 100 percent of such expenditures from a MBE or WBE manufacturer.

(F) Manufacturers and Regular Dealers

A contractor may count toward its MBE or WBE requirement the following expenditures to MBE/WBE firms that are not manufacturers or regular dealers:

- (1) The fees or commissions charged by a MBE/WBE firm for providing a *bona fide* service, such as professional, technical, consultant, or managerial services, or for providing bonds or insurance specifically required for the performance of a DOT-assisted contract, provided the fees or commissions are determined to be reasonable and not excessive as compared with fees and commissions customarily allowed for similar services.
- (2) With respect to materials or supplies purchased from a MBE/WBE, which is neither a manufacturer nor a regular dealer, count the entire amount of fees or commissions charged for assistance in the procurement of the materials and supplies, or fees or transportation charges for the delivery of materials or supplies required on a job site (but not the cost of the materials and supplies themselves), provided the fees are determined to be reasonable and not excessive as compared with fees customarily allowed for similar services.

Commercially Useful Function

(A) MBE/WBE Utilization

The Contractor may count toward its contract goal requirement only expenditures to MBEs and WBEs that perform a commercially useful function in the work of a contract. A MBE/WBE performs a commercially useful function when it is responsible for execution of the work of the contract and is carrying out its responsibilities by actually performing, managing, and supervising the work involved. To perform a commercially useful function, the MBE/WBE shall also be responsible with respect to materials and supplies used on the contract, for negotiating price, determining quality and quantity, ordering the material and installing (where applicable) and paying for the material itself. To determine whether a MBE/WBE is performing a commercially useful function, the Department will evaluate the amount of work subcontracted, industry practices, whether the amount the firm is to be paid under the contract is commensurate with the work it is actually performing and the MBE/WBE credit claimed for its performance of the work, and any other relevant factors.

(B) MBE/WBE Utilization in Trucking

The following factors will be used to determine if a MBE or WBE trucking firm is performing a commercially useful function:

- (1) The MBE/WBE shall be responsible for the management and supervision of the entire trucking operation for which it is responsible on a particular contract, and there shall not be a contrived arrangement for the purpose of meeting the MBE or WBE goal.
- (2) The MBE/WBE shall itself own and operate at least one fully licensed, insured, and operational truck used on the contract.
- (3) The MBE/WBE receives credit for the total value of the transportation services it provides on the contract using trucks it owns, insures, and operates using drivers it employs.
- (4) The MBE may subcontract the work to another MBE firm, including an owner-operator who is certified as a MBE. The same holds true that a WBE may subcontract the work to another WBE firm, including an owner-operator who is certified as a WBE. When this occurs, the MBE or WBE who subcontracts work receives credit for the total value of the transportation services the subcontracted MBE or WBE provides on the contract. It should be noted that every effort shall be made by MBE and WBE contractors to subcontract to the same certification (i.e., MBEs to MBEs and WBEs to WBEs), in order to fulfill the goal requirement. This, however, may not always be possible due to the limitation of firms in the area. If the MBE or WBE firm shows a good faith effort has been made to reach out to similarly certified transportation service providers and there is no interest or availability, and they can get assistance from other certified providers, the Engineer will not hold the prime liable for meeting the goal.
- (5) The MBE/WBE may also subcontract the work to a non-MBE/WBE firm, including from an owner-operator. The MBE/WBE who subcontracts the work to a non-MBE/WBE is entitled to credit for the total value of transportation services provided by the non-MBE/WBE subcontractor not to exceed the value of transportation services provided by MBE/WBE-owned trucks on the contract. Additional participation by non-MBE/WBE subcontractors receives credit only for the fee or commission it receives as a result of the subcontract arrangement. The value of services performed under subcontract agreements between the MBE/WBE and the Contractor will not count towards the MBE/WBE contract requirement.

- (6) A MBE/WBE may lease truck(s) from an established equipment leasing business open to the general public. The lease must indicate that the MBE/WBE has exclusive use of and control over the truck. This requirement does not preclude the leased truck from working for others during the term of the lease with the consent of the MBE/WBE, so long as the lease gives the MBE/WBE absolute priority for use of the leased truck. This type of lease may count toward the MBE/WBE's credit as long as the driver is under the MBE/WBE's payroll.
- (7) Subcontracted/leased trucks shall display clearly on the dashboard the name of the MBE/WBE that they are subcontracted/leased to and their own company name if it is not identified on the truck itself. Magnetic door signs are not permitted.

MBE/WBE Replacement

When a Contractor has relied on a commitment to a MBE or WBE firm (or an approved substitute MBE or WBE firm) to meet all or part of a contract goal requirement, the contractor shall not terminate the MBE/WBE for convenience. This includes, but is not limited to, instances in which the Contractor seeks to perform the work of the terminated subcontractor with another MBE/WBE subcontractor, a non-MBE/WBE subcontractor, or with the Contractor's own forces or those of an affiliate. A MBE/WBE may only be terminated after receiving the Engineer's written approval based upon a finding of good cause for the termination.

All requests for replacement of a committed MBE/WBE firm shall be submitted to the Engineer for approval on Form RF-1 (*Replacement Request*). If the Contractor fails to follow this procedure, the Contractor may be disqualified from further bidding for a period of up to 6 months.

The Contractor shall comply with the following for replacement of a committed MBE/WBE:

(A) Performance Related Replacement

When a committed MBE is terminated for good cause as stated above, an additional MBE that was submitted at the time of bid may be used to fulfill the MBE commitment. The same holds true if a committed WBE is terminated for good cause, an additional WBE that was submitted at the time of bid may be used to fulfill the WBE goal. A good faith effort will only be required for removing a committed MBE/WBE if there were no additional MBEs/WBEs submitted at the time of bid to cover the same amount of work as the MBE/WBE that was terminated.

If a replacement MBE/WBE is not found that can perform at least the same amount of work as the terminated MBE/WBE, the Contractor shall submit a good faith effort documenting the steps taken. Such documentation shall include, but not be limited to, the following:

- (1) Copies of written notification to MBEs/WBEs that their interest is solicited in contracting the work defaulted by the previous MBE/WBE or in subcontracting other items of work in the contract.
- (2) Efforts to negotiate with MBEs/WBEs for specific subbids including, at a minimum:
 - (a) The names, addresses, and telephone numbers of MBEs/WBEs who were contacted.
 - (b) A description of the information provided to MBEs/WBEs regarding the plans and specifications for portions of the work to be performed.
- (3) A list of reasons why MBE/WBE quotes were not accepted.
- (4) Efforts made to assist the MBEs/WBEs contacted, if needed, in obtaining bonding or insurance required by the Contractor.

(B) Decertification Replacement

- (1) When a committed MBE/WBE is decertified by the Department after the SAF (*Subcontract Approval Form*) has been received by the Department, the Department will not require the Contractor to solicit replacement MBE/WBE participation equal to the remaining work to be performed by the decertified firm. The participation equal to the remaining work performed by the decertified firm will count toward the contract goal requirement.
- (2) When a committed MBE/WBE is decertified prior to the Department receiving the SAF (*Subcontract Approval Form*) for the named MBE/WBE firm, the Contractor shall take all necessary and reasonable steps to replace the MBE/WBE subcontractor with another similarly certified MBE/WBE subcontractor to perform at least the same amount of work to meet the MBE/WBE goal requirement. If a MBE/WBE firm is not found to do the same amount of work, a good faith effort must be submitted to NCDOT (see A herein for required documentation).

Changes in the Work

When the Engineer makes changes that result in the reduction or elimination of work to be performed by a committed MBE/WBE, the Contractor will not be required to seek additional participation. When the Engineer makes changes that result in additional work to be performed by a MBE/WBE based upon the Contractor's commitment, the MBE/WBE shall participate in additional work to the same extent as the MBE/WBE participated in the original contract work.

When the Engineer makes changes that result in extra work, which has more than a minimal impact on the contract amount, the Contractor shall seek additional participation by MBEs/WBEs unless otherwise approved by the Engineer.

When the Engineer makes changes that result in an alteration of plans or details of construction, and a portion or all of the work had been expected to be performed by a committed MBE/WBE, the Contractor shall seek participation by MBEs/WBEs unless otherwise approved by the Engineer.

When the Contractor requests changes in the work that result in the reduction or elimination of work that the Contractor committed to be performed by a MBE/WBE, the Contractor shall seek additional participation by MBEs/WBEs equal to the reduced MBE/WBE participation caused by the changes.

Reports and Documentation

A SAF (*Subcontract Approval Form*) shall be submitted for all work which is to be performed by a MBE/WBE subcontractor. The Department reserves the right to require copies of actual subcontract agreements involving MBE/WBE subcontractors.

When using transportation services to meet the contract commitment, the Contractor shall submit a proposed trucking plan in addition to the SAF. The plan shall be submitted prior to beginning construction on the project. The plan shall include the names of all trucking firms proposed for use, their certification type(s), the number of trucks owned by the firm, as well as the individual truck identification numbers, and the line item(s) being performed.

Within 30 calendar days of entering into an agreement with a MBE/WBE for materials, supplies or services, not otherwise documented by the SAF as specified above, the Contractor shall furnish the Engineer a copy of the agreement. The documentation shall also indicate the percentage (60% or 100%) of expenditures claimed for MBE/WBE credit.

Reporting Minority and Women Business Enterprise Participation

The Contractor shall provide the Engineer with an accounting of payments made to all MBE and WBE firms, including material suppliers and contractors at all levels (prime, subcontractor, or second tier subcontractor). This accounting shall be furnished to the Engineer for any given month by the end of the following month. Failure to submit this information accordingly may result in the following action:

- (A) Withholding of money due in the next partial pay estimate; or
- (B) Removal of an approved contractor from the prequalified bidders' list or the removal of other entities from the approved subcontractors list.

While each contractor (prime, subcontractor, 2nd tier subcontractor) is responsible for accurate accounting of payments to MBEs/WBEs, it shall be the prime contractor's responsibility to report all monthly and final payment information in the correct reporting manner.

Failure on the part of the Contractor to submit the required information in the time frame specified may result in the disqualification of that contractor and any affiliate companies from further bidding until the required information is submitted.

Failure on the part of any subcontractor to submit the required information in the time frame specified may result in the disqualification of that contractor and any affiliate companies from being approved for further work on future projects until the required information is submitted.

Contractors reporting transportation services provided by non-MBE/WBE lessees shall evaluate the value of services provided during the month of the reporting period only.

At any time, the Engineer can request written verification of subcontractor payments.

The Contractor shall report the accounting of payments on the Department's DBE-IS (*Subcontractor Payment Information*) with each invoice. Invoices will not be processed for payment until the DBE-IS is received.

Failure to Meet Contract Requirements

Failure to meet contract requirements in accordance with Subarticle 102-15(J) of the *2012 Standard Specifications* may be cause to disqualify the Contractor.

VICINITY MAP

Work Order Numbers: 6C.043122
State Road Number: 2309 (Leanna Lane)

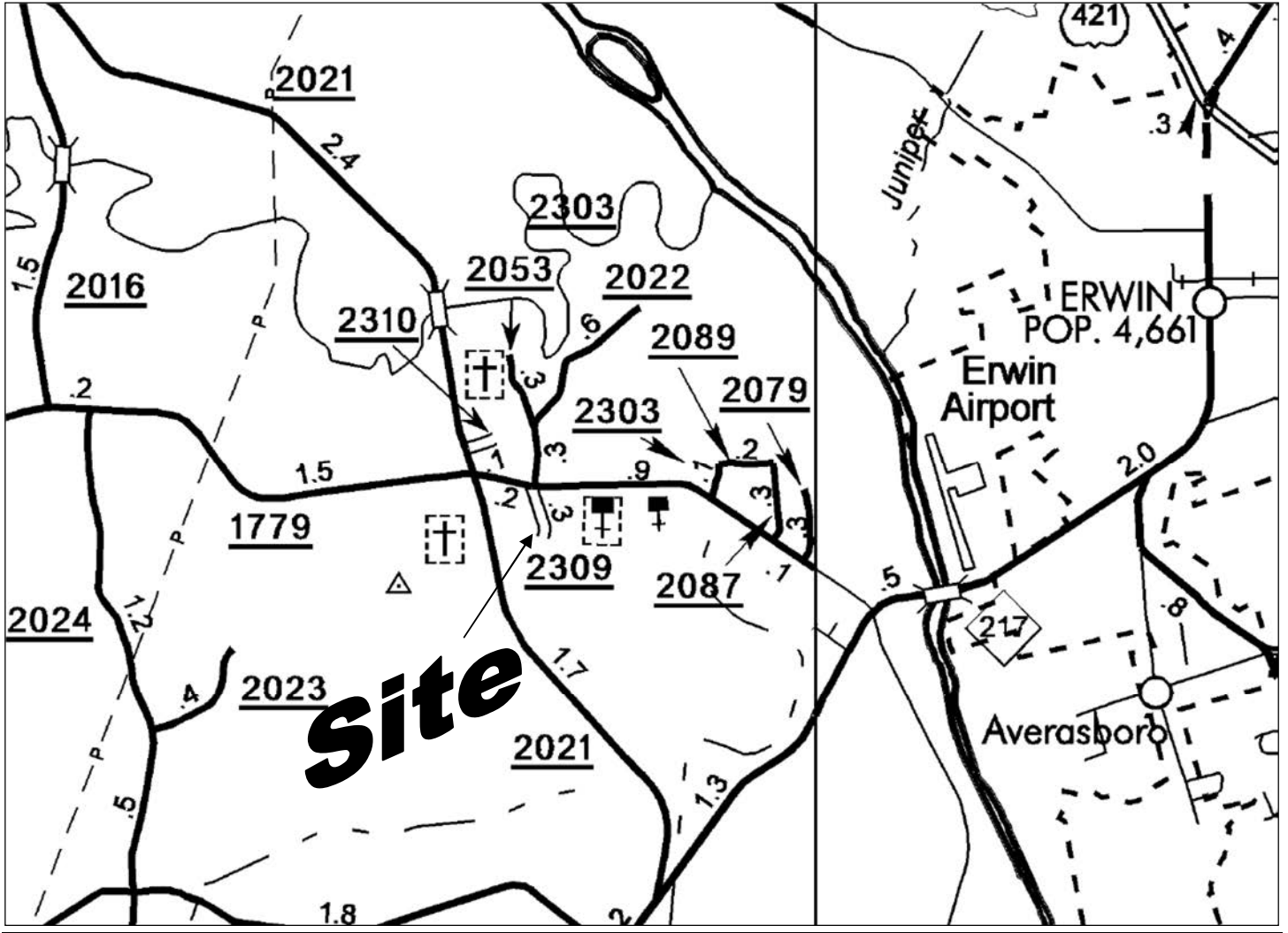

TYPICAL SECTION

Work Order Number: 6C.043122

State Road Number: 2309 (Leanna Lane)

To be used in Tangent Sections

(Curves shall be super elevated to the inside of the curve at 0.25 in./ft. transitioning 100 feet before the PC and 100 feet after the PT where applicable)

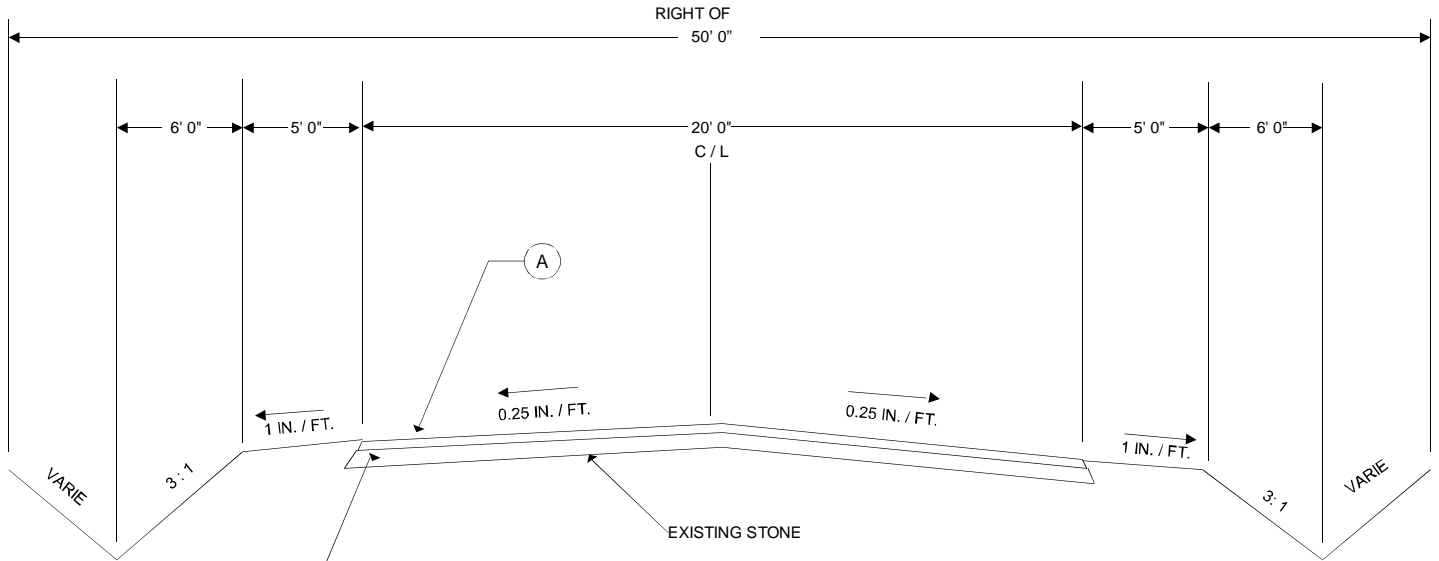

PAVEMENT SCHEDULE	
A	Proposed ACSC Type SF 9.5A, At An Average Rate of 165 Lbs./Sq. Yd.
B	Proposed 6" Aggregate Base Course (ABC)

2 FT. WIDENING DETAIL

Work Order Number: 6C.043122

State Road Number: 2309 (Leanna Lane)

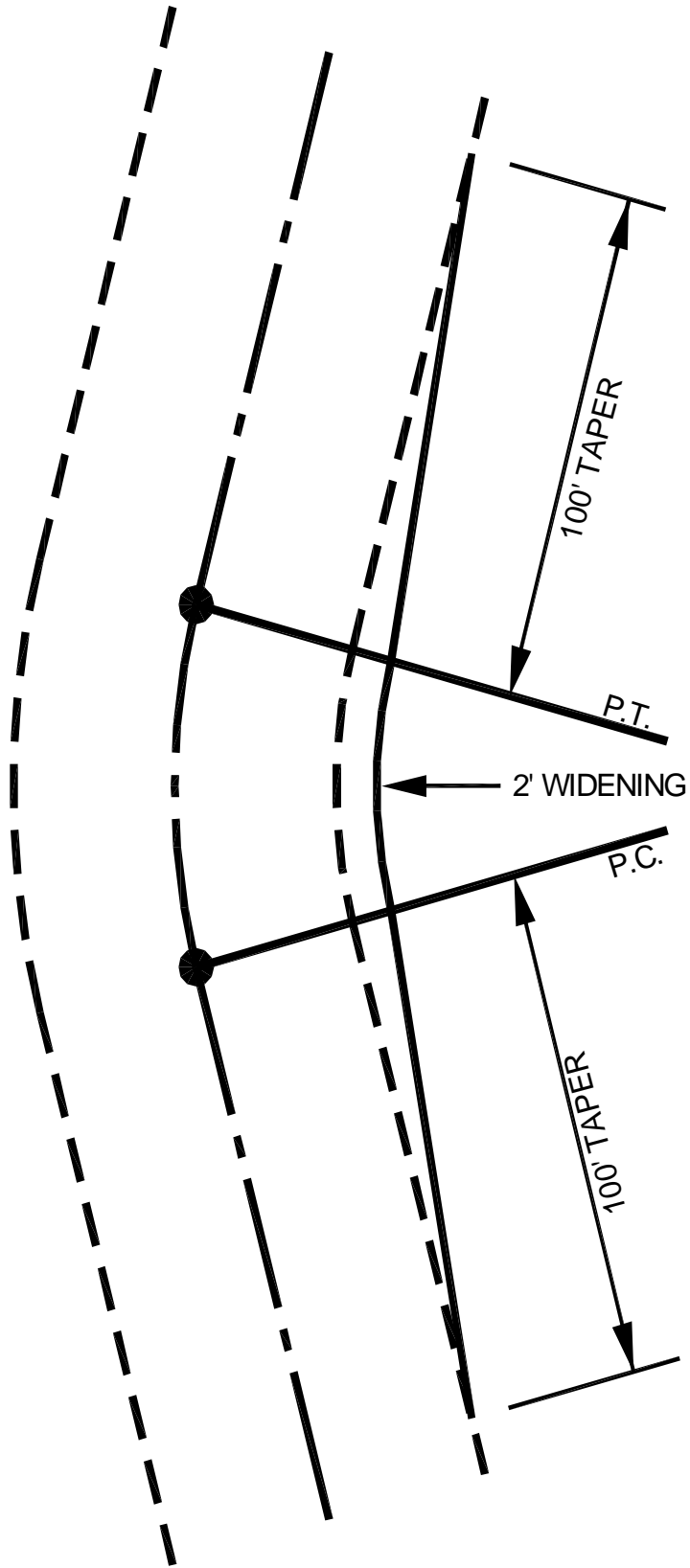

2 FT.
WIDENING OF
INSIDE
RADIUS FOR
CURVES

FIRE HYDRANT RELOCATION DETAIL

Work Order Number: 6C.043122
State Road Number: 2309 (Leanna Lane)

- GENERAL:**
1. LOCATE FIRE HYDRANT BEHIND BACK OF DITCH OR AT THE RIGHT OF WAY LINE. WHERE THERE IS NO DITCH, THE HYDRANT SHALL BE PLACED AS FAR AS POSSIBLE FROM PAVEMENT EDGE WITHIN RIGHT OF WAY OUTER LIMITS. PUMPER NOZZLE SHALL BE PERPENDICULAR TO ROADWAY.
 2. ALL CONCRETE SHALL BE CLASS "B".
 3. BOLTS, NUTS, AND DRAIN PORTS TO BE FREE OF CONCRETE.
 4. HYDRANT BRANCH SHALL HAVE SAME COVER AS THE MAIN (36" MIN. BRANCH).
 5. ALL PIPE JOINTS BETWEEN THE VALVE AND THE HYDRANT SHALL HAVE RESTRAINED RETAINER GLANDS.

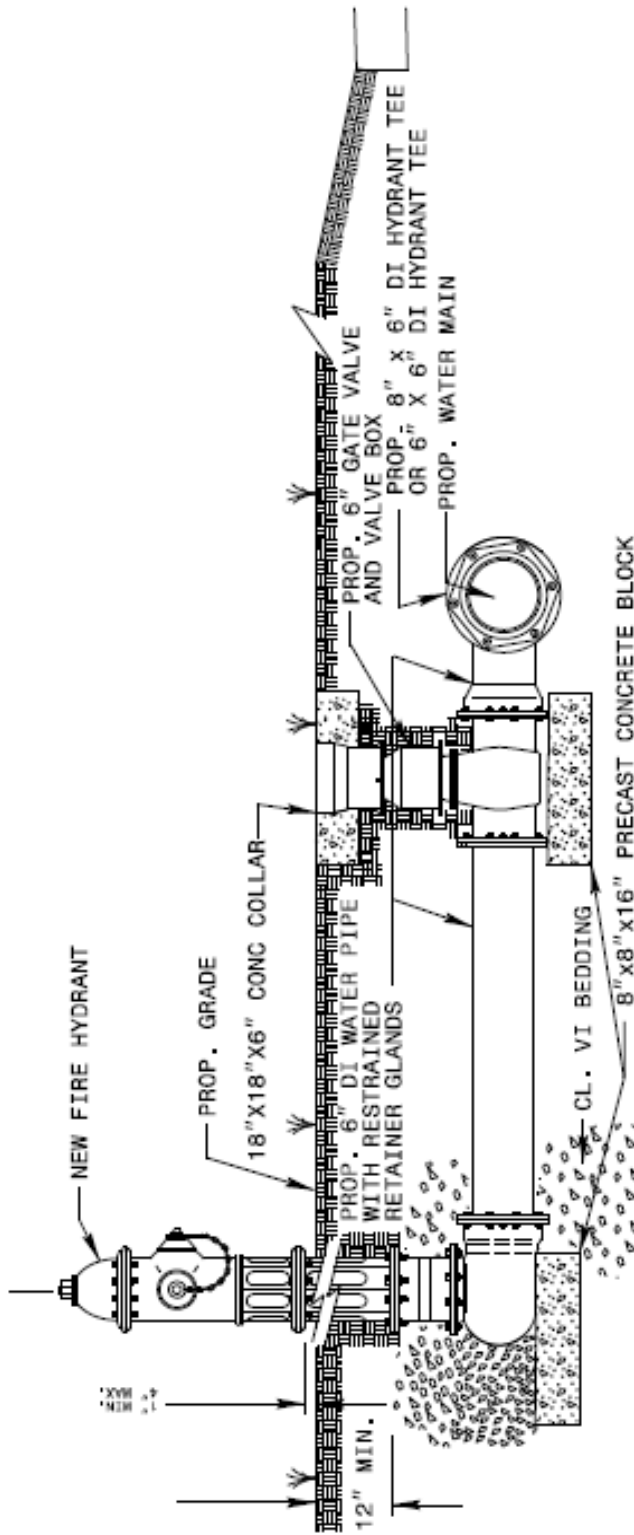

NOTE: ALL ITEMS ARE INCIDENTAL TO THE FIRE HYDRANT RELOCATION INCLUDING BUT NOT LIMITED TO ALL DUCTILE IRON FITTINGS.

FIRE HYDRANT DETAIL

WATER METER RELOCATION DETAIL

Work Order Number: 6C.043122
State Road Number: 2309 (Leanna Lane)

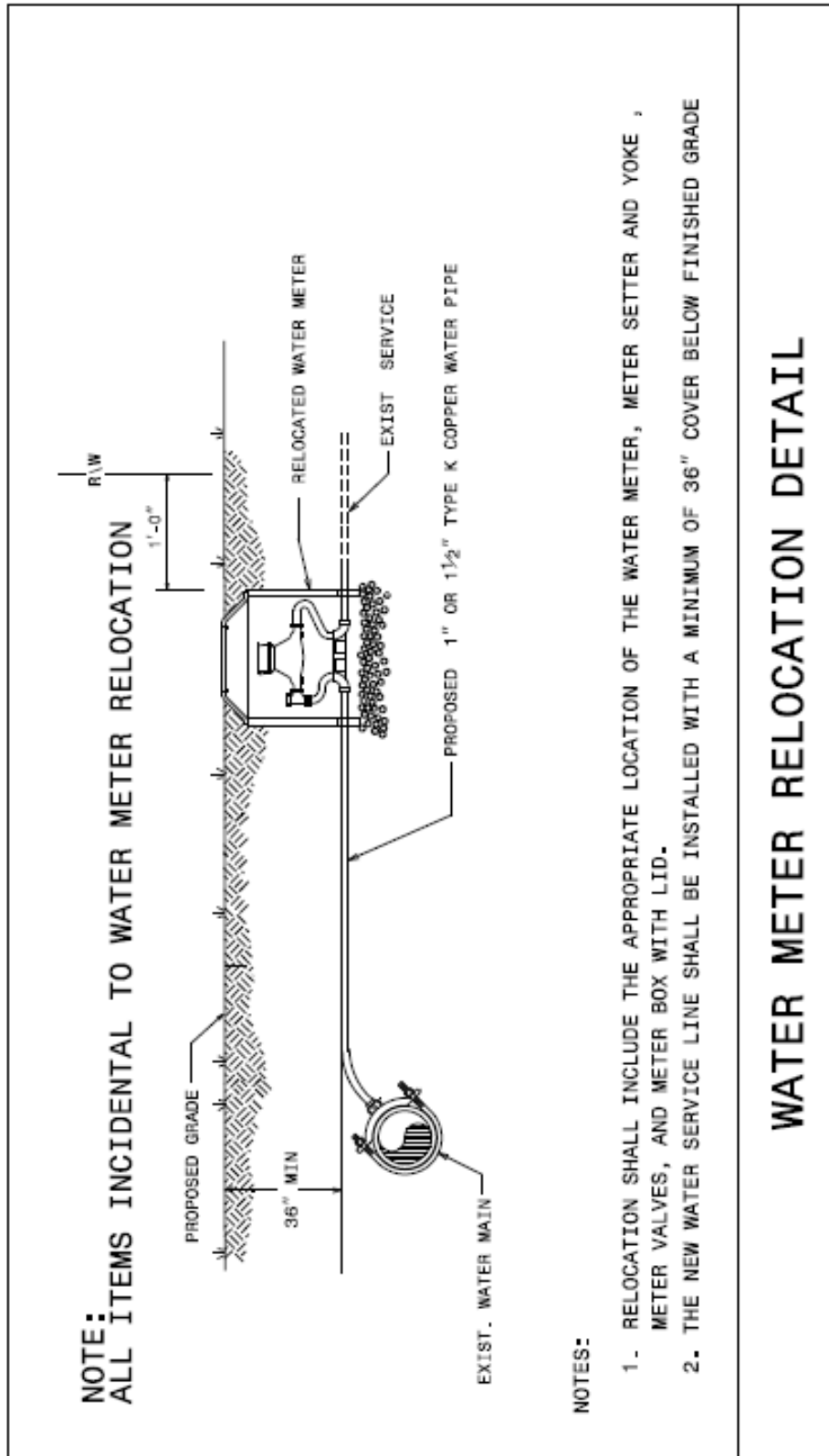

TEMPORARY ROCK SILT CHECK, TYPE A, WITH MATTING AND POLYACRYLAMIDE (PAM) DETAIL

Work Order Number: 6C.043122
 State Road Number: 2309 (Leanna Lane)

TEMPORARY ROCK SILT CHECK TYPE 'A' WITH EXCELSIOR MATTING AND POLYACRYLAMIDE (PAM) DETAIL

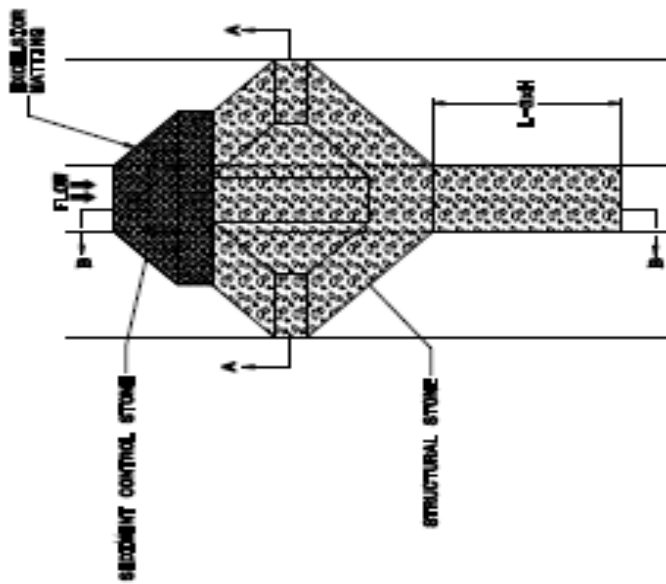

NOTE

USE EXCELSIOR FOR MATTING MATERIAL AND ANCHOR MATTING SECTION AT TOP AND BOTTOM WITH CLASS B STONE. INITIALLY APPLY 3.5 OUNCES OF POLYACRYLAMIDE (PAM) TO TOP OF MATTING SECTION AND AFTER EVERY RAINFALL EVENT THAT EQUALS OR EXCEEDS 0.50 INCHES.

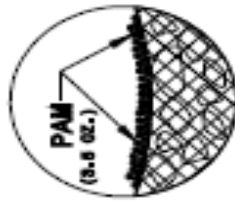

INSET A

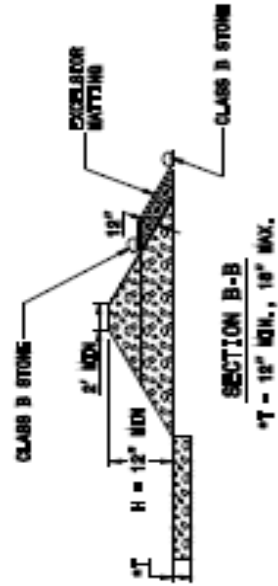
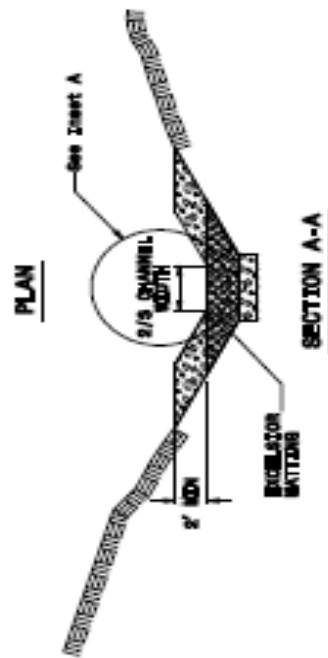

DEWATERING – BYPASS PUMPING DETAIL

Work Order Number: 6C.043122
State Road Number: 2309 (Leanna Lane)

MANAGING THE WATERCOURSE: BYPASS PUMPING

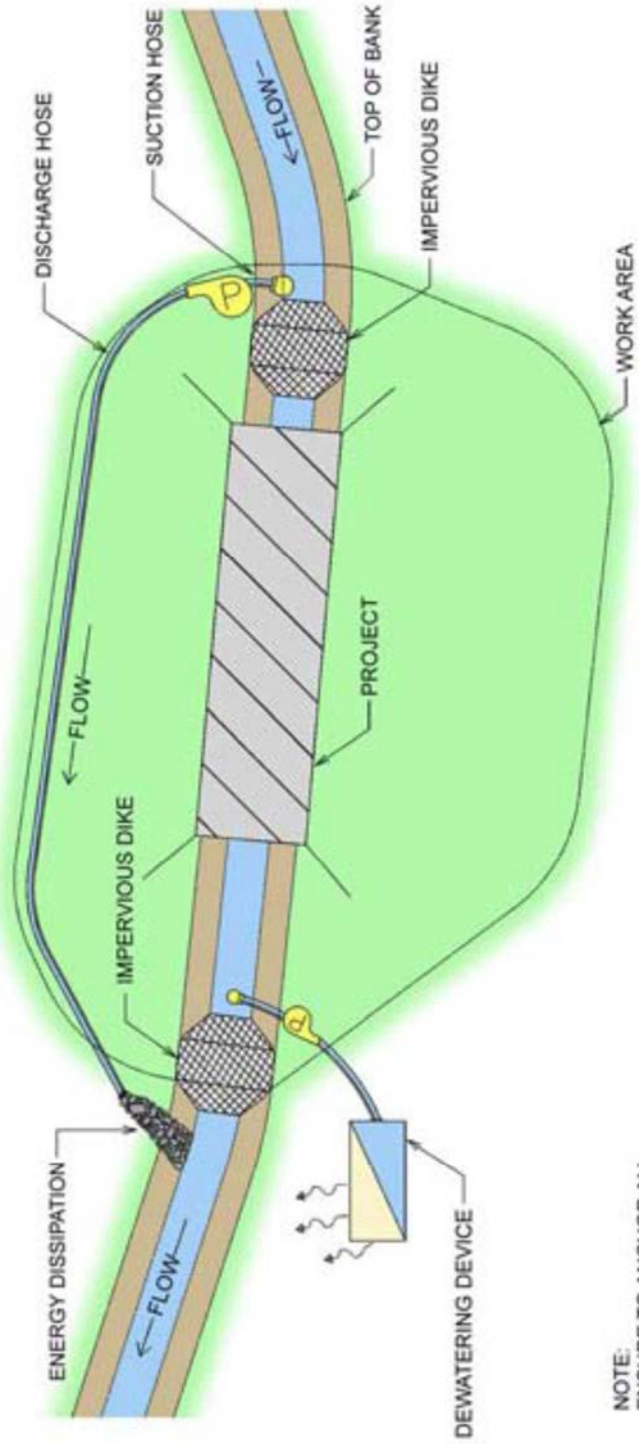

NOTE:
ENSURE TO ANCHOR ALL
PUMPS AND PIPES SECURELY.

NORTH CAROLINA DEPARTMENT OF TRANSPORTATION
AUGUST 2003

BMPs FOR CONSTRUCTION AND MAINTENANCE ACTIVITIES

PERMITTED PIPE REPLACEMENT

Work Order Number: 6C.043122

State Road Number: 2309 (Leanna Lane)

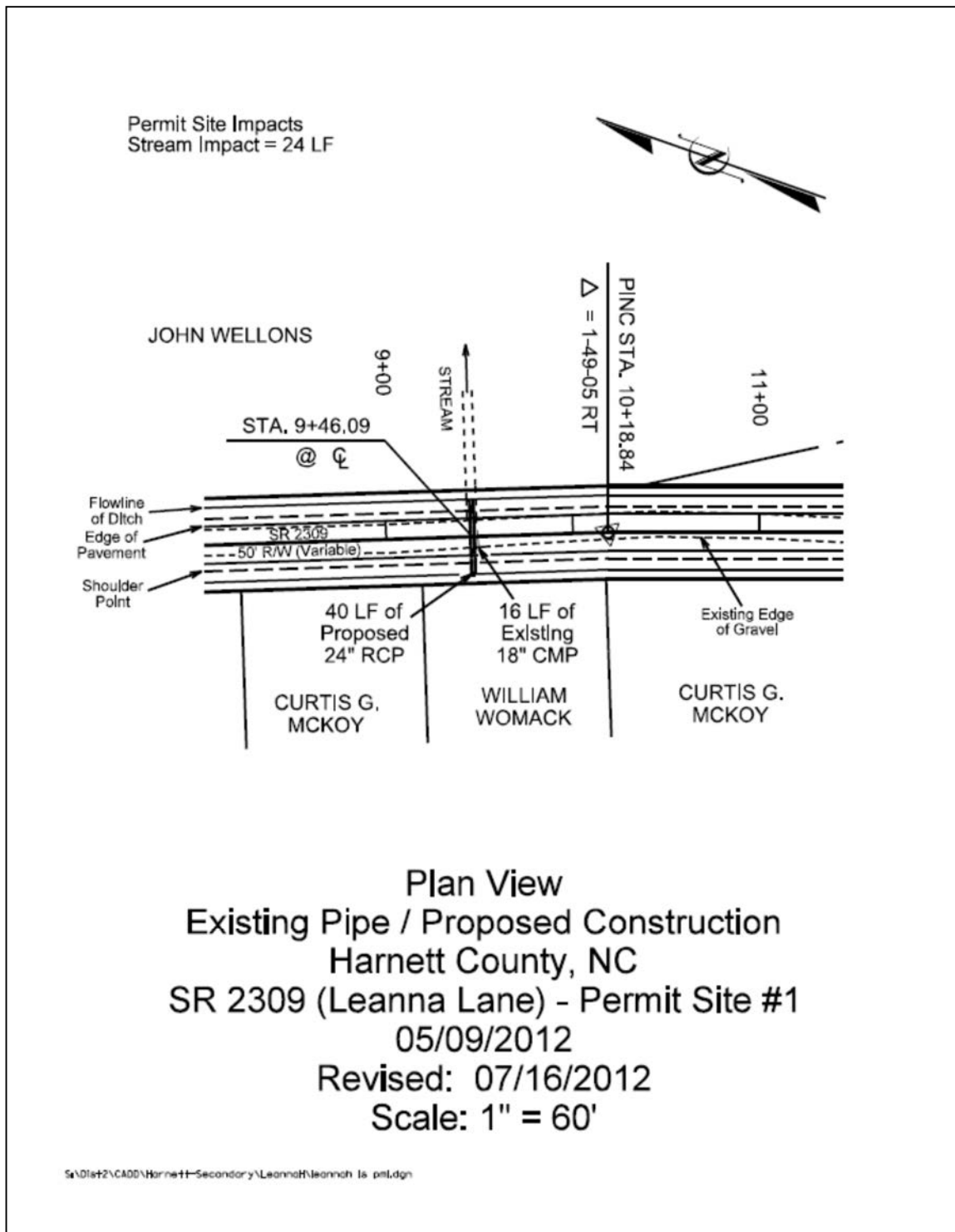

PERMITTED PIPE REPLACEMENT

Work Order Number: 6C.043122
State Road Number: 2309 (Leanna Lane)

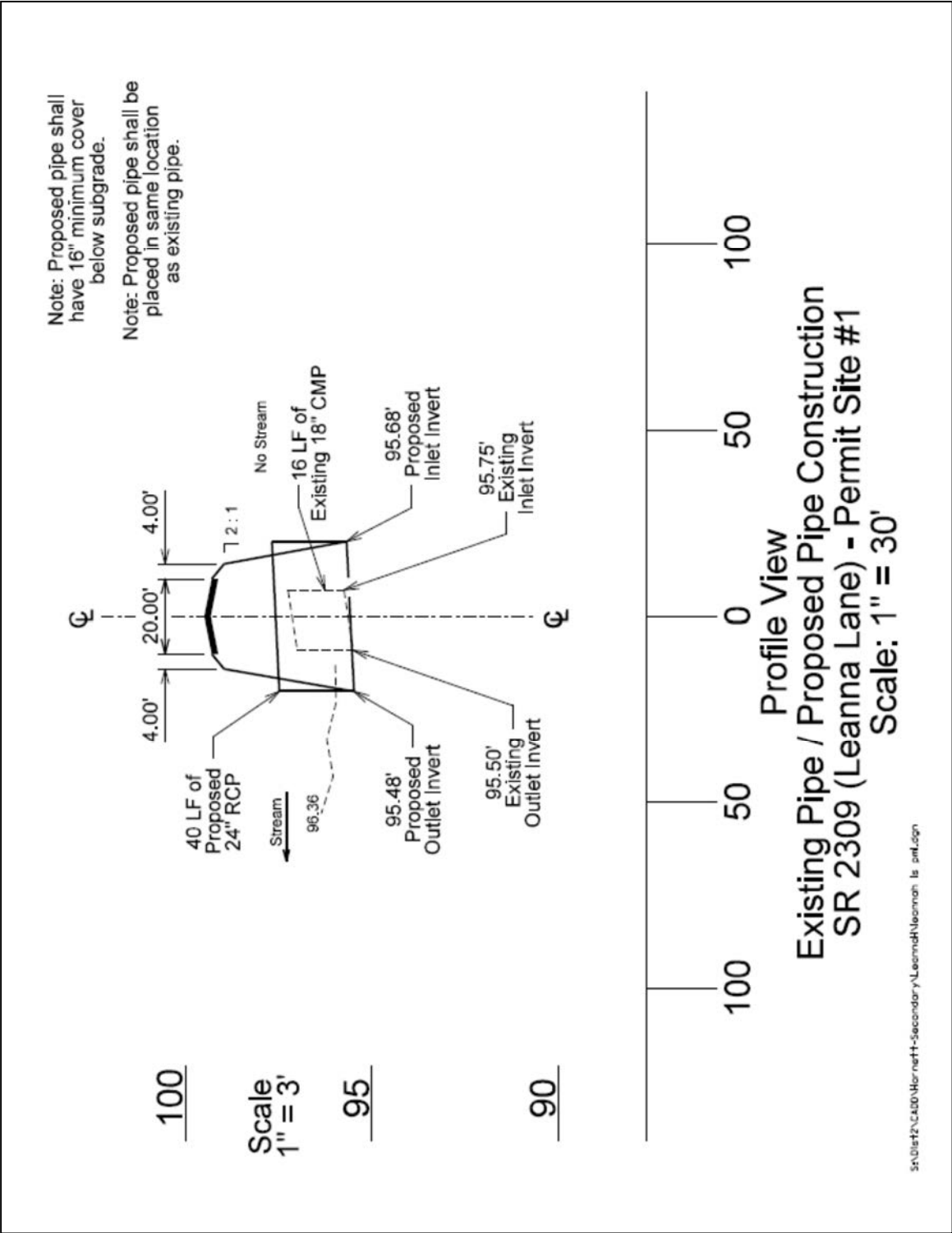

Note: Proposed pipe shall have 16" minimum cover below subgrade.

Note: Proposed pipe shall be placed in same location as existing pipe.

PERMITTED PIPE REPLACEMENT

Work Order Number: 6C.043122

State Road Number: 2309 (Leanna Lane)

Permit Site Impacts
Stream Impact = 25 LF
Wetland Impact = 0.037 Acres in R/W

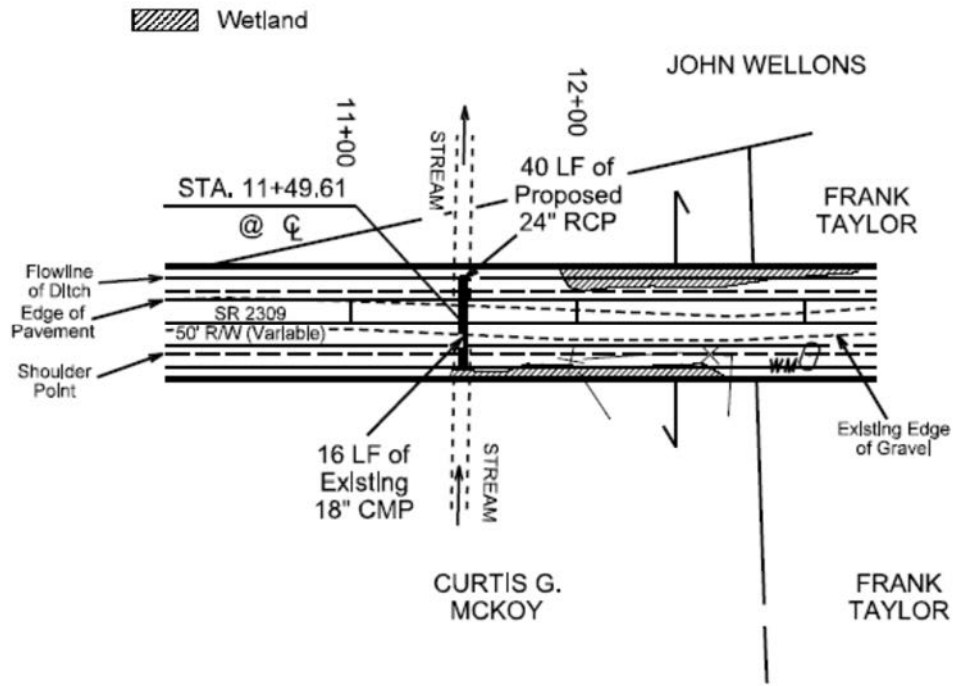

Plan View

Existing Pipe / Proposed Construction
Harnett County, NC
SR 2309 (Leanna Lane) - Permit Site #2
05/09/2012
Revised: 07/16/2012
Scale: 1" = 60'

S:\Dist2\CA00\Harnett-Secondary\Leanna\leanna1a.pit.dgn

PERMITTED PIPE REPLACEMENT

Work Order Number: 6C.043122
State Road Number: 2309 (Leanna Lane)

Note: Proposed pipe shall have 16" minimum cover below subgrade.

Note: Proposed pipe shall be placed in same location as existing pipe.

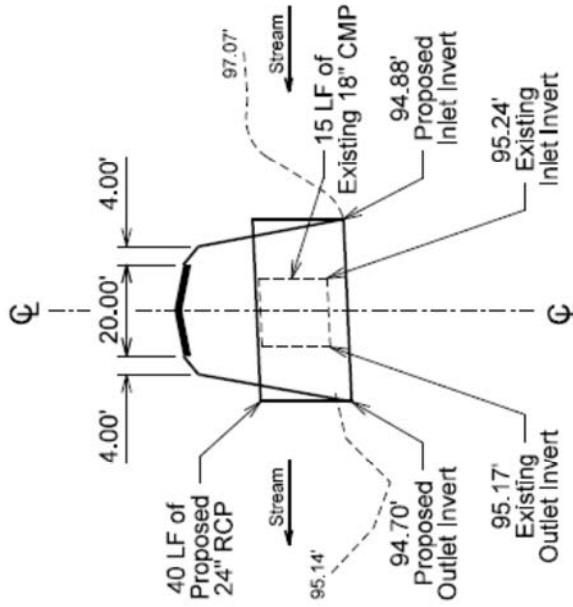

100

Scale
1" = 3'

95

90

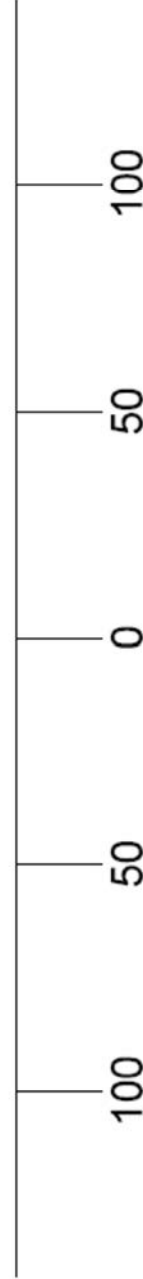

Profile View
Existing Pipe / Proposed Pipe Construction
SR 2309 (Leanna Lane) - Permit Site #2
Scale: 1" = 30'

S:\011412\CADD\Hornett-Secondary\Leanna\Neannon Is .pdf.dgn

WETLAND DELINEATION

Work Order Number: 6C.043122
State Road Number: 2309 (Leanna Lane)

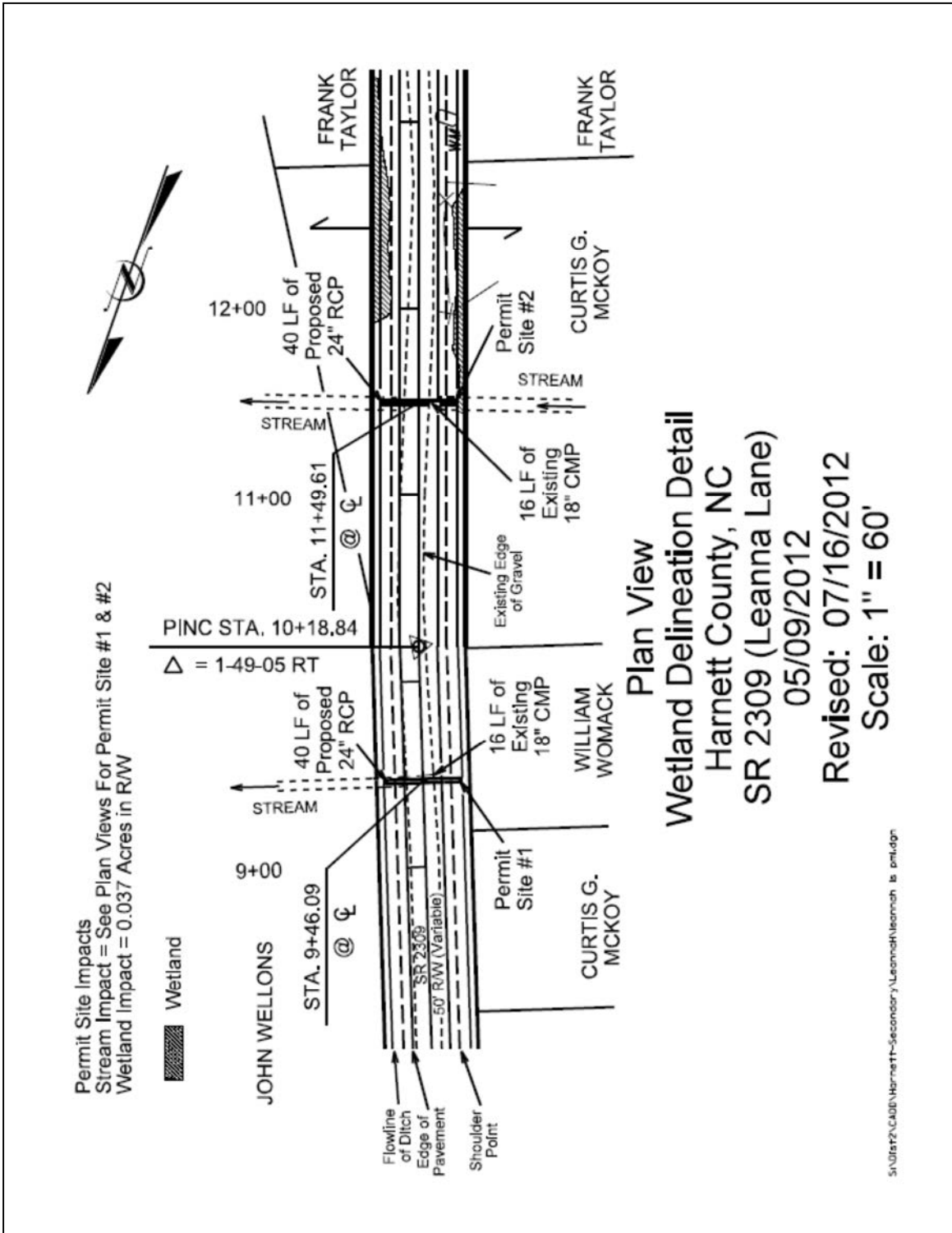

AWARD LIMITS ON MULTIPLE PROJECTS

It is the desire of the Proposer to be awarded contracts, the value of which will not exceed a total of \$ _____, for those projects indicated below on which bids are being opened on the same date as shown in the Proposal Form. Individual projects shall be indicated by placing the project number and county in the appropriate place below. Projects not selected will not be subject to an award limit.

(Project Number)

(County)

(Project Number)

(County)

(Project Number)

(County)

(Project Number)

(County)

*If a Proposer desires to limit the total amount of work awarded to him in this letting, he shall state such limit in the space provided above in the second line of this form.

It is agreed that in the event that I am (we are) the successful bidder on indicated projects, the total value of which is more than the above stipulated award limits, the Board of Transportation will award me (us) projects from among those indicated which have a total value not exceeding the award limit and which will result in the best advantage to the Department of Transportation.

**Signature of Authorized Person

**Only those persons authorized to sign bids under the provisions of Article 102-8, Item 7, shall be authorized to sign this form.

**EXECUTION OF BID
NON-COLLUSION AFFIDAVIT, DEBARMENT CERTIFICATION AND GIFT BAN CERTIFICATION**

CORPORATION

The person executing the bid, on behalf of the Bidder, being duly sworn, solemnly swears (or affirms) that neither he, nor any official, agent or employee of the bidder has entered into any agreement, participated in any collusion, or otherwise taken any action which is in restraint of free competitive bidding in connection with any bid or contract, that the bidder has not been convicted of violating N.C.G.S. § 133-24 within the last three years, and that the Bidder intends to do the work with its own bonafide employees or subcontractors and is not bidding for the benefit of another contractor.

In addition, execution of this bid in the proper manner also constitutes the Bidder's certification of status under penalty of perjury under the laws of the United States in accordance with the Debarment Certification attached, provided that the Debarment Certification also includes any required statements concerning exceptions that are applicable.

N.C.G.S. § 133-32 and Executive Order 24 prohibit the offer to, or acceptance by, any State Employee of any gift from anyone with a contract with the State, or from any person seeking to do business with the State. By execution of any response in this procurement, you attest, for your entire organization and its employees or agents, that you are not aware that any such gift has been offered, accepted, or promised by any employees of your organization.

SIGNATURE OF CONTRACTOR

_____ Full name of Corporation

_____ Address as prequalified

Attest _____
Secretary/Assistant Secretary
Select appropriate title

By _____
President/Vice President/Assistant Vice President
Select appropriate title

_____ Print or type Signer's name

_____ Print or type Signer's name

CORPORATE SEAL

AFFIDAVIT MUST BE NOTARIZED

NOTARY SEAL

Subscribed and sworn to before me this the
_____ day of _____, 20_____

Signature of Notary Public
Of _____ County
State of _____
My Commission Expires _____

**EXECUTION OF BID
NON-COLLUSION AFFIDAVIT, DEBARMENT CERTIFICATION AND GIFT BAN CERTIFICATION**

PARTNERSHIP

The person executing the bid, on behalf of the Bidder, being duly sworn, solemnly swears (or affirms) that neither he, nor any official, agent or employee of the bidder has entered into any agreement, participated in any collusion, or otherwise taken any action which is in restraint of free competitive bidding in connection with any bid or contract, that the bidder has not been convicted of violating *N.C.G.S. § 133-24* within the last three years, and that the Bidder intends to do the work with its own bonafide employees or subcontractors and is not bidding for the benefit of another contractor.

In addition, execution of this bid in the proper manner also constitutes the Bidder's certification of status under penalty of perjury under the laws of the United States in accordance with the Debarment Certification attached, provided that the Debarment Certification also includes any required statements concerning exceptions that are applicable.

N.C.G.S. § 133-32 and Executive Order 24 prohibit the offer to, or acceptance by, any State Employee of any gift from anyone with a contract with the State, or from any person seeking to do business with the State. By execution of any response in this procurement, you attest, for your entire organization and its employees or agents, that you are not aware that any such gift has been offered, accepted, or promised by any employees of your organization.

SIGNATURE OF CONTRACTOR

Full Name of Partnership		
Address as Prequalified		
Signature of Witness	By	Signature of Partner
Print or type Signer's name		Print or type Signer's name

AFFIDAVIT MUST BE NOTARIZED

Subscribed and sworn to before me this the
day of _____ 20_____.

NOTARY SEAL

Signature of Notary Public

of _____ County

State of _____

My Commission Expires: _____

**EXECUTION OF BID
NON-COLLUSION AFFIDAVIT, DEBARMENT CERTIFICATION AND GIFT BAN CERTIFICATION**

LIMITED LIABILITY COMPANY

The person executing the bid, on behalf of the Bidder, being duly sworn, solemnly swears (or affirms) that neither he, nor any official, agent or employee of the bidder has entered into any agreement, participated in any collusion, or otherwise taken any action which is in restraint of free competitive bidding in connection with any bid or contract, that the bidder has not been convicted of violating N.C.G.S. § 133-24 within the last three years, and that the Bidder intends to do the work with its own bonafide employees or subcontractors and is not bidding for the benefit of another contractor.

In addition, execution of this bid in the proper manner also constitutes the Bidder's certification of status under penalty of perjury under the laws of the United States in accordance with the Debarment Certification attached, provided that the Debarment Certification also includes any required statements concerning exceptions that are applicable.

N.C.G.S. § 133-32 and Executive Order 24 prohibit the offer to, or acceptance by, any State Employee of any gift from anyone with a contract with the State, or from any person seeking to do business with the State. By execution of any response in this procurement, you attest, for your entire organization and its employees or agents, that you are not aware that any such gift has been offered, accepted, or promised by any employees of your organization.

SIGNATURE OF CONTRACTOR

_____ Full Name of Firm

_____ Address as Prequalified

_____ Signature of Witness	Signature of Manager	_____ Individually
-------------------------------	-------------------------	-----------------------

_____ Print or type Signer's name	_____ Print or type Signer's Name
--------------------------------------	--------------------------------------

AFFIDAVIT MUST BE NOTARIZED

Subscribed and sworn to before me this the
____ day of _____ 20__.

Signature of Notary Public

of _____ County

State of _____

My Commission Expires: _____

NOTARY SEAL

**EXECUTION OF BID
NON-COLLUSION AFFIDAVIT, DEBARMENT CERTIFICATION AND GIFT BAN CERTIFICATION**

JOINT VENTURE (2) or (3)

The person executing the bid, on behalf of the Bidder, being duly sworn, solemnly swears (or affirms) that neither he, nor any official, agent or employee of the bidder has entered into any agreement, participated in any collusion, or otherwise taken any action which is in restraint of free competitive bidding in connection with any bid or contract, that the bidder has not been convicted of violating N.C.G.S. § 133-24 within the last three years, and that the Bidder intends to do the work with its own bonafide employees or subcontractors and is not bidding for the benefit of another contractor.

In addition, execution of this bid in the proper manner also constitutes the Bidder's certification of status under penalty of perjury under the laws of the United States in accordance with the Debarment Certification attached, provided that the Debarment Certification also includes any required statements concerning exceptions that are applicable.

N.C.G.S. § 133-32 and Executive Order 24 prohibit the offer to, or acceptance by, any State Employee of any gift from anyone with a contract with the State, or from any person seeking to do business with the State. By execution of any response in this procurement, you attest, for your entire organization and its employees or agents, that you are not aware that any such gift has been offered, accepted, or promised by any employees of your organization.

SIGNATURE OF CONTRACTOR

Instructions: **2 Joint Venturers** Fill in lines (1), (2) and (3) and execute. **3 Joint Venturers** Fill in lines (1), (2), (3) and (4) and execute. On Line (1), fill in the name of the Joint Venture Company. On Line (2), fill in the name of one of the joint venturers and execute below in the appropriate manner. On Line (3), print or type the name of the other joint venturer and execute below in the appropriate manner. On Line (4), fill in the name of the third joint venturer, if applicable and execute below in the appropriate manner.

(1) _____
Name of Joint Venture

(2) _____
Name of Contractor

_____ Address as prequalified

_____ Signature of Witness or Attest	By	_____ Signature of Contractor
_____ Print or type Signer's name		_____ Print or type Signer's name

If Corporation, affix Corporate Seal and

(3) _____
Name of Contractor

_____ Address as prequalified

_____ Signature of Witness or Attest	By	_____ Signature of Contractor
_____ Print or type Signer's name		_____ Print or type Signer's name

If Corporation, affix Corporate Seal and

(4) _____
Name of Contractor (for 3 Joint Venture only)

_____ Address as prequalified

_____ Signature of Witness or Attest	By	_____ Signature of Contractor
_____ Print or type Signer's name		_____ Print or type Signer's name

If Corporation, affix Corporate Seal

NOTARY SEAL
Affidavit must be notarized for Line (2)
Subscribed and sworn to before me this _____ day of _____ 20_____

Signature of Notary Public
of _____ County
State of _____
My Commission Expires: _____

NOTARY SEAL
Affidavit must be notarized for Line (3)
Subscribed and sworn to before me this _____ day of _____ 20_____

Signature of Notary Public
of _____ County
State of _____
My Commission Expires: _____

NOTARY SEAL
Affidavit must be notarized for Line (4)
Subscribed and sworn to before me this _____ day of _____ 20_____

Signature of Notary Public
of _____ County
State of _____
My Commission Expires: _____

**EXECUTION OF BID
NON-COLLUSION AFFIDAVIT, DEBARMENT CERTIFICATION AND GIFT BAN CERTIFICATION**

INDIVIDUAL DOING BUSINESS UNDER A FIRM NAME

The person executing the bid, on behalf of the Bidder, being duly sworn, solemnly swears (or affirms) that neither he, nor any official, agent or employee of the bidder has entered into any agreement, participated in any collusion, or otherwise taken any action which is in restraint of free competitive bidding in connection with any bid or contract, that the bidder has not been convicted of violating N.C.G.S. § 133-24 within the last three years, and that the Bidder intends to do the work with its own bonafide employees or subcontractors and is not bidding for the benefit of another contractor.

In addition, execution of this bid in the proper manner also constitutes the Bidder's certification of status under penalty of perjury under the laws of the United States in accordance with the Debarment Certification attached, provided that the Debarment Certification also includes any required statements concerning exceptions that are applicable.

N.C.G.S. § 133-32 and Executive Order 24 prohibit the offer to, or acceptance by, any State Employee of any gift from anyone with a contract with the State, or from any person seeking to do business with the State. By execution of any response in this procurement, you attest, for your entire organization and its employees or agents, that you are not aware that any such gift has been offered, accepted, or promised by any employees of your organization.

SIGNATURE OF CONTRACTOR

Name of Contractor

_____ Individual name

Trading and doing business as

_____ Full name of Firm

_____ Address as Prequalified

_____ Signature of Witness

_____ Signature of Contractor, Individually

_____ Print or type Signer's name

_____ Print or type Signer's name

AFFIDAVIT MUST BE NOTARIZED

Subscribed and sworn to before me this the

NOTARY SEAL

_____ day of _____ 20__.

_____ Signature of Notary Public

of _____ County

State of _____

My Commission Expires: _____

**EXECUTION OF BID
NON-COLLUSION AFFIDAVIT, DEBARMENT CERTIFICATION AND GIFT BAN CERTIFICATION**

INDIVIDUAL DOING BUSINESS IN HIS OWN NAME

The person executing the bid, on behalf of the Bidder, being duly sworn, solemnly swears (or affirms) that neither he, nor any official, agent or employee of the bidder has entered into any agreement, participated in any collusion, or otherwise taken any action which is in restraint of free competitive bidding in connection with any bid or contract, that the bidder has not been convicted of violating *N.C.G.S. § 133-24* within the last three years, and that the Bidder intends to do the work with its own bonafide employees or subcontractors and is not bidding for the benefit of another contractor.

In addition, execution of this bid in the proper manner also constitutes the Bidder's certification of status under penalty of perjury under the laws of the United States in accordance with the Debarment Certification attached, provided that the Debarment Certification also includes any required statements concerning exceptions that are applicable.

N.C.G.S. § 133-32 and Executive Order 24 prohibit the offer to, or acceptance by, any State Employee of any gift from anyone with a contract with the State, or from any person seeking to do business with the State. By execution of any response in this procurement, you attest, for your entire organization and its employees or agents, that you are not aware that any such gift has been offered, accepted, or promised by any employees of your organization.

SIGNATURE OF CONTRACTOR

Name of Contractor _____
Print or type Individual name

Address as Prequalified

Signature of Contractor, Individually

Print or type Signer's Name

Signature of Witness

Print or type Signer's name

AFFIDAVIT MUST BE NOTARIZED

Subscribed and sworn to before me this the _____ day of _____ 20__.

NOTARY SEAL

Signature of Notary Public

of _____ County

State of _____

My Commission Expires: _____

DEBARMENT CERTIFICATION

Conditions for certification:

1. The prequalified bidder shall provide immediate written notice to the Department if at any time the bidder learns that his certification was erroneous when he submitted his debarment certification or explanation that is file with the Department, or has become erroneous because of changed circumstances.
2. The terms *covered transaction, debarred, suspended, ineligible, lower tier covered transaction, participant, person, primary covered transaction, principal, proposal, and voluntarily excluded*, as used in this provision, have the meanings set out in the Definitions and Coverage sections of the rules implementing Executive Order 12549. A copy of the Federal Rules requiring this certification and detailing the definitions and coverages may be obtained from the Contract Officer of the Department.
3. The prequalified bidder agrees by submitting this form, that he will not knowingly enter into any lower tier covered transaction with a person who is debarred, suspended, declared ineligible, or voluntarily excluded from participation in NCDOT contracts, unless authorized by the Department.
4. For Federal Aid projects, the prequalified bidder further agrees that by submitting this form he will include the Federal-Aid Provision titled *Required Contract Provisions Federal-Aid Construction Contract (Form FHWA PR 1273)* provided by the Department, without subsequent modification, in all lower tier covered transactions.
5. The prequalified bidder may rely upon a certification of a participant in a lower tier covered transaction that he is not debarred, suspended, ineligible, or voluntarily excluded from the covered transaction, unless he knows that the certification is erroneous. The bidder may decide the method and frequency by which he will determine the eligibility of his subcontractors.
6. Nothing contained in the foregoing shall be construed to require establishment of a system of records in order to render in good faith the certification required by this provision. The knowledge and information of a participant is not required to exceed that which is normally possessed by a prudent person in the ordinary course of business dealings.
7. Except as authorized in paragraph 6 herein, the Department may terminate any contract if the bidder knowingly enters into a lower tier covered transaction with a person who is suspended, debarred, ineligible, or voluntarily excluded from participation in this transaction, in addition to other remedies available by the Federal Government.

DEBARMENT CERTIFICATION

The prequalified bidder certifies to the best of his knowledge and belief, that he and his principals:

- a. Are not presently debarred, suspended, proposed for debarment, declared ineligible, or voluntarily excluded from covered transactions by any Federal department or agency;
- b. Have not within a three-year period preceding this proposal been convicted of or had a civil judgment rendered against them for commission of fraud or a criminal offense in connection with obtaining, attempting to obtain, or performing a public (Federal, State or local) transaction or contract under a public transaction; violation of Federal or State antitrust statutes or commission of embezzlement, theft, forgery, bribery, falsification or destruction of records; making false statements; or receiving stolen property;
- c. Are not presently indicted for or otherwise criminally or civilly charged by a governmental entity (Federal, State or local) with commission of any of the offenses enumerated in paragraph b. of this certification; and
- d. Have not within a three-year period preceding this proposal had one or more public transactions (Federal, State or local) terminated for cause or default.
- e. Will submit a revised Debarment Certification immediately if his status changes and will show in his bid proposal an explanation for the change in status.

If the prequalified bidder cannot certify that he is not debarred, he shall provide an explanation with this submittal. An explanation will not necessarily result in denial of participation in a contract.

Failure to submit a non-collusion affidavit and debarment certification will result in the prequalified bidder's bid being considered non-responsive.

Check here if an explanation is attached to this certification.

**SUBSTITUTE FORM W-9
VENDOR REGISTRATION FORM
NORTH CAROLINA DEPARTMENT OF TRANSPORTATION**

Pursuant to Internal Revenue Service (IRS) Regulations, vendors must furnish their Taxpayer Identification Number (TIN) to the State. If this number is not provided, you may be subject to a 20% withholding on each payment. To avoid this 20% withholding and to insure that accurate tax information is reported to the Internal Revenue Service and the State, please use this form to provide the requested information exactly as it appears on file with the IRS.

INDIVIDUAL AND SOLE PROPRIETOR: ENTER NAME AS SHOWN ON SOCIAL SECURITY CARD

CORPORATION OR PARTNERSHIP : ENTER YOUR LEGAL BUSINESS NAME

NAME: _____

MAILING ADDRESS: STREET/PO BOX: _____

CITY, STATE, ZIP: _____

DBA / TRADE NAME (IF APPLICABLE): _____

BUSINESS DESIGNATION:

- INDIVIDUAL (use _____) SOLE PROPRIETOR (use SS No. or Fed ID _____)
 CORPORATION (use Federal ID No.) PARTNERSHIP (use Federal ID No.)
 ESTATE/TRUST (use Federal ID no.) STATE OR LOCAL GOVT. (use Federal ID No.)
 OTHER / SPECIFY _____

SOCIAL SECURITY NO. _____ - _____ - _____ (Social Security #)

OR
FED.EMPLOYER IDENTIFICATION NO. _____ - _____ - _____ (Employer Identification #)

COMPLETE THIS SECTION IF PAYMENTS ARE MADE TO AN ADDRESS OTHER THAN THE ONE LISTED ABOVE: REMIT TO ADDRESS: STREET / PO BOX: _____ CITY, STATE, ZIP: _____

<p>Participation in this section is voluntary. You are not required to complete this section to become a registered vendor. The information below will in no way affect the vendor registration process and its sole purpose is to collect statistical data on those vendors doing business with NCDOT. If you choose to participate, circle the answer that best fits your firm's group definition.</p> <p>What is your firm's ethnicity? (<input type="checkbox"/>Prefer Not To Answer, <input type="checkbox"/>African American, <input type="checkbox"/>Native American, <input type="checkbox"/>Caucasian American, <input type="checkbox"/>Asian American, <input type="checkbox"/>Hispanic American, <input type="checkbox"/>Asian-Indian American, <input type="checkbox"/>Other: _____)</p> <p>What is your firm's gender? (<input type="checkbox"/>Prefer Not to Answer, <input type="checkbox"/> Male, <input type="checkbox"/>Female) Disabled-Owned Business? (<input type="checkbox"/>Prefer Not to Answer, <input type="checkbox"/>Yes, <input type="checkbox"/> No)</p>

IRS Certification

Under penalties of perjury, I certify that:

1. The number shown on this form is my correct taxpayer identification and
2. I am not subject to backup withholding because: (a) I am exempt from backup withholding, or (b) I have not been notified by the IRS that I am subject to backup withholding as a result of a failure to report all interest or dividends, or (c) the IRS has notified me that I am no longer subject to backup withholding, and
3. I am a U.S. person (including a U.S. resident alien).

The IRS does not require your consent to any provision of this document other than the certifications required to avoid backup withholding. For complete certification instructions please see IRS FORM W-9 at <http://www.irs.gov/pub/irs-pdf/fw9.pdf> .

NAME (Print or Type) _____

TITLE (Print or Type) _____

SIGNATURE _____

DATE _____

PHONE NUMBER _____

To avoid payment delays, completed forms should be returned promptly to your local DOT office.

**State of North Carolina
Department of Transportation
Subcontractor Payment Information**

Submit with Invoice To: District Engineer
North Carolina Department of Transportation
Division 6 / District 2
P.O. Box 1150
Fayetteville, NC 28302

Firm Invoice No. Reference
NC DOT PO / Contract Number
WBS No. (State Project No.)
Date of Invoice

Invoice Line Item Reference	Payer Name	Payer Federal Tax Id	Subcontractor/ Subconsultant/ Material Supplier Name	Subcontractor/ Subconsultant/ Material Supplier Federal Tax Id	Amount Paid To Subcontractor/ Subconsultant/ Material Supplier This Invoice	Date Paid To Subcontractor/ Subconsultant/ Material Supplier This Invoice

Note: These documents are scanned into the NCDOT Fiscal Program. Please do not highlight or shade the figures.

Total Amount Paid to Subcontractor Firms \$

Certification of Firm

I certify that this information accurately reflects actual payments made and the dates the payments were made to Subcontractors/
Subconsultants/Material Suppliers on the above referenced project.

Signature <input style="width: 150px;" type="text"/>	Title <input style="width: 150px;" type="text"/>
Print Name <input style="width: 150px;" type="text"/>	Date <input style="width: 100px;" type="text"/>



North Carolina Department of Transportation DIVISION CONTRACT BID FORM

Work Order Number: 6C.043122
State Road Number: 2309 (Leanna Lane)
 Harnett County

LINE	ITEM	SECT	DESCRIPTION	QTY	UNIT	UNIT PRICE	AMOUNT BID
10	0000100000-N	SP	Mobilization	2	LS		
20	0001000000-E	200	Clearing and Grubbing	1	LS		
30	0036000000-E	SP	Undercut Excavation	200	CY		
40	0063000000-N	SP	Comprehensive Grading	1	LS		
50	0106000000-E	SP	Borrow Material	225	CY		
60	0366000000-E	SP	15" RC Pipe Culvert, Class III	192	LF		
70	0372000000-E	SP	18" RC Pipe Culvert, Class III	44	LF		
80	0378000000-E	SP	24" RC Pipe Culvert, Class III	80	LF		
90	0995000000-E	SP	Pipe Removal	223	LF		
100	1121000000-E	SP	Aggregate Base Course	1306	Ton		
110	1220000000-E	SP	Incidental Stone Base	80	Ton		
120	1525000000-E	610	ACSC Type SF 9.5 A	340	Ton		
130	1575000000-E	620	Asphalt Binder, PG 64-22	23	Ton		
140	6000000000-E	1605	Temporary Silt Fence (1605.01)	3316	LF		
150	6015000000-E	1615	Temporary Mulching	1.1	Acre		
160	6018000000-E	1620	Seed for Temporary Seeding	55	LB		
170	6021000000-E	1620	Fertilizer for Temporary Seeding	0.28	Ton		
180	6029000000-E	SP	Safety Fence	400	LF		
190	6036000000-E	SP	Matting for Erosion Control (8' Excelsior)	845	SY		



DIVISION CONTRACT BID FORM (continued)

LINE	ITEM	SECT	DESCRIPTION	QTY	UNIT	UNIT PRICE	AMOUNT BID
200	6071010000-E	SP	Temporary Excelsior Wattle	160	LF		
210	6071020000-E	SP	Polyacrylamide (PAM)	10	LB		
220	6084000000-E	1660	Seeding and Mulching (Permanent)	2.2	Acre		
230	6132000000-N	SP	Special Sediment Control Fence (1606.01)	20	LF		
240	8804000000-N	SP	Dewatering	2	Each		

The Contractor shall note that the above mentioned quantities are used only for determining the low responsible bidder.

TOTAL BID FOR WORK ORDER NUMBER 6C.043122:



DIVISION CONTRACT BID FORM (continued)

NOTE: Bids are required on all contingent items. Any proposals which do not have a bid for contingent items will be considered non-responsive and will not be considered for award of contract.

CONTINGENT ITEMS

LINE	ITEM	SECT	DESCRIPTION	QTY	UNIT	UNIT PRICE	AMOUNT BID
250	0318000000-E	SP	Foundation Conditioning Material	20	Ton		
260	2845000000-N	858	Water Valve Adjustment	1	Each		
270	3656000000-E	876	Geotextile for Drainage, Type 2	40	SY		
280	5325200000-E	1510	2" Water Line	50	LF		
290	5648000000-E	1515	Relocate Water Meter	1	Each		
300	5672000000-E	1515	Relocate Fire Hydrant	1	Each		
310	6024000000-E	1622	Temporary Slope Drain (1622.01)	20	LF		
320	6132000000-N	SP	Temporary Rock Silt Check, Type A, with Excelsior Matting	1	Each		
330	6132000000-N	SP	Temporary Rock Silt Check, Type A (1633.01)	1	Each		
340	6132000000-N	SP	Temporary Rock Silt Check, Type B (1633.02)	1	Each		
350	6132000000-N	1634	Temporary Rock Sediment Dam, Type B (1634.02)	1	Each		
360	6132000000-N	1632	Rock Inlet Sediment Trap, Type C (1632.03)	1	Each		
370	8594000000-E	876	Rip Rap, Class B	20	Ton		



DIVISION CONTRACT BID FORM (continued)

CONTRACTOR _____

ADDRESS _____

Federal Identification Number _____ Contractors License Number _____

Authorized Agent _____ Title _____

Signature _____ Date _____

Witness _____ Title _____

Signature _____ Date _____

Point of Contact for Post Bid Inquiries (e.g., Letters of Intent, Insurance, Bonds, Contract Execution, etc.):

Name _____

Email _____

Phone _____

THIS SECTION TO BE COMPLETED BY NORTH CAROLINA DEPARTMENT OF TRANSPORTATION

This bid has been reviewed in accordance with Article 103-1 of the current edition of the **Standard Specifications for Roads and Structures**.

Division Proposals Engineer

Date